



DIAMOND VANTAGE®

PRODUCT CATALOG

**OUR PRIMARY WAREHOUSE AND US MANUFACTURING FACILITY IS HEADQUARTERED IN IRVINE, CA.**

To better serve our customers, we have selected strategic warehouse locations throughout the U.S. that will reduce transportation time and cost

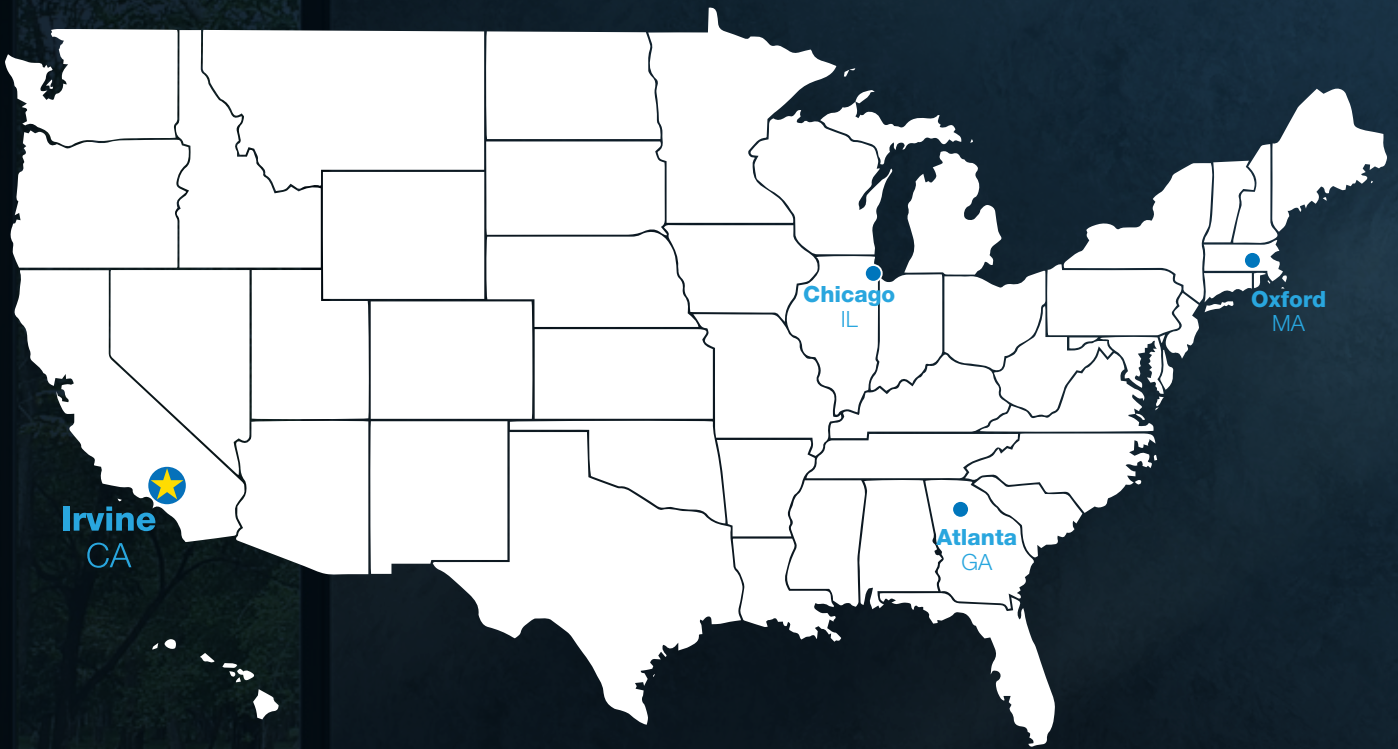

**Irvine**  
CA

**Chicago**  
IL

**Atlanta**  
GA

**Oxford**  
MA

**WEST REGION**

2025 Alton Pkwy  
Irvine, CA 92606

**MIDWEST REGION**

655 Wheat Lane,  
Wood Dale, IL 60191

**EAST REGION**

31 Town Forest Road,  
Oxford, MA 01540

**SOUTHEAST REGION**

1902 Forge St,  
Tucker, GA 30084





## EXPECT THE BEST

Since 2003, Diamond Vantage® has been serving the construction and stone industries with diamond tools that yield the highest level of performance. From its inception, Diamond Vantage® has been working to become the BEST supplier to our customer by continuing to upgrade in all areas of our product line and customer services.

We have our most exciting product lineup to date, and have included all our new products in this beautiful catalog. We have made great strides to make the catalog more useful than ever. Grades, bonds, and other specifications are all clearly presented for each product.

Diamond Vantage® diamond tools are used in all areas, from highways, to bridges, to buildings, and everywhere in-between. We strive to be the leader in diamond tool manufacturing by providing our customers with the BEST quality and service, exceeding industry expectations. Diamond Vantage® manufactures a complete range of construction diamond tools designed for maximum performance. Such products include: flat saw blades, wall saw blades, hand saw blades, small diameter blades, diamond wire, cup wheels, core bits, specialty products and much more!

### TRUTH IN ENGINEERING

- What sets Diamond Vantage® apart from most of its competition is that we are a true manufacturer. Unlike most of our competition, we manufacture 100% of the diamond tools we sell.
- The result is quality, consistency, innovation, and competitive pricing.
- Experienced product engineers for technical support and problem solving.
- Manufacture a full range of diamond tools.
- Engineered to reduce customer operating costs.

### TRUTH IN MARKETING

- Extensive national sales & marketing support.
- Complete sales support and training.

### TRUTH IN SOLUTIONS

- Large inventory for quick turnaround.
- Private label & co-branding.
- Incentive programs tailored to meet each customer's request and needs.

### TRUTH IN VALUE

- Industry leader in innovation.
- Lowest standard pricing in the industry.



# TABLE OF CONTENTS

01

## **BRANDS WE OFFER**

Diamond Vantage®, ZENESIS™, DiamondX®, Gorilla Concrete Tools, Hakken™, EIBENSTOCK™

03

## **HOW DIAMOND BLADES WORK**

04

## **UNDERSTANDING THE AGGREGATES**

05

## **CHOOSE FROM THOUSANDS OF SPECS**

07

## **PART NUMBER CHART & ICON LEGEND**

08

## **BOND SELECTION CHART**

09

## **PROFESSIONAL SERIES (35-120HP) & SPECIALTY PRODUCTS**

12" - 60" Blades for Concrete, Asphalt & Asphalt Overlay Pavement Grinding,  
Diamond Wire & Ring Saw Blades

19

## **CORE DRILLING**

Wet & Dry Core Bits for Concrete, Masonry, General Purpose and Asphalt,  
Extensions & Adapters



**25**

**HIGH SPEED • MASONRY  
LOW HP FLAT SAW BLADES**

12" - 24" Blades for Hard Materials, General Purpose, Concrete, Asphalt, Abrasive Materials & All-Purpose

**36**

**EARLY ENTRY • GREEN CONCRETE**

Green Concrete Blades & Skid Plates

**40**

**SMALL DIAMETER**

4" - 10" Blades for Hard Materials, General Purpose, Abrasive Materials

**47**

**TUCK POINT • CRACK CHASER**

Standard, Double, & Triple Tuck Point Blades; V-Shaped & Crack Chasers

**51**

**GRINDING & SURFACE PREPARATION PRODUCTS**

Cup Wheels, Grinding Blocks, Grinding Wheels, Grinding Heads, F.A.S.T. System, Polishing Pads

**61**

**TILE PRODUCTS**

ZENESIS™, For Ceramic, Porcelain (Wet & Dry), Glass, General Purpose, Profile Wheel, Dressing Stones, Diamond Hand Pads and Core Bits

**69**

**STONE PRODUCTS**

ZENESIS™, Bridge Saw Blades, Turbo Blades, Contour Blades, Multi-Grinder, Electroplated Multi-Cutter, Core Bits, CNC Products, Polishing Pads, Cup Wheels, Shaping Tools

**90**

**METAL CUTTING**

DiamondX®

**95**

**EQUIPMENT**

Diamond Vantage®, Hakken™, Gorilla Concrete Tools, EIBENSTOCK™

**103**

**TERMS & CONDITIONS • TROUBLESHOOTING**

Policies & Warranties



Introducing **DC350LM**, our most powerful single phase dust extractor. Portable and easy to maneuver on jobsite floors.

The **MDE350** Dry Masonry Saw features a powerful 3HP motor and 14" blade capacity for fast cutting of brick/block and general purpose applications. The saw can also be used wet with our optional wet kit. The powerful dust collector kit (optional) ensures clean cutting, indoors or out.

The new **FS200-14K** is built from the ground up to provide years of reliable cutting. This saw will cut concrete and asphalt with little to no vibration because of its heavy-gauge steel frame, rugged shaft and bearing assembly.



DC350LM

MDE350

FS200-14K

## ZENESIS™

**WORLD'S MOST ADVANCED PATTERNED DIAMOND TECHNOLOGY GETS EVEN BETTER**



- Hybrid Layering Technology maximizes exposed diamonds
- Maximizes product consistency
- Significantly improves both cutting speed and blade life
- Enables cost-effective mass production
- Protected by patented technologies

## DIAMOND<sup>X</sup>®

### NEW DIAMOND TOOLS FOR DEMANDING METAL-WORKING APPLICATIONS

DIAMOND<sup>X</sup>® is a new generation of tools for the metal-working industry. DIAMOND<sup>X</sup>® concentrates a large number of diamond grits on a single layer with an incredibly strong bond. This technology allows DIAMOND<sup>X</sup>® to cut and grind materials that traditional diamond tools could not.

Applications:  
High & Low Carbon Steel, Hard Facing Alloys, Ductile Iron, Rail Track, Steel Section, Bar & Tube Wood, Plastic, FRP, PVC





**GorillaConcreteTools**
**AMERICAN MADE. OHIO TESTED.**

- Early Entry Saws for Green Concrete
- Virtually Dust Free Cutting
- No Slurry/Water
- Military Tested And Approved
- Proudly Made In Ohio, USA

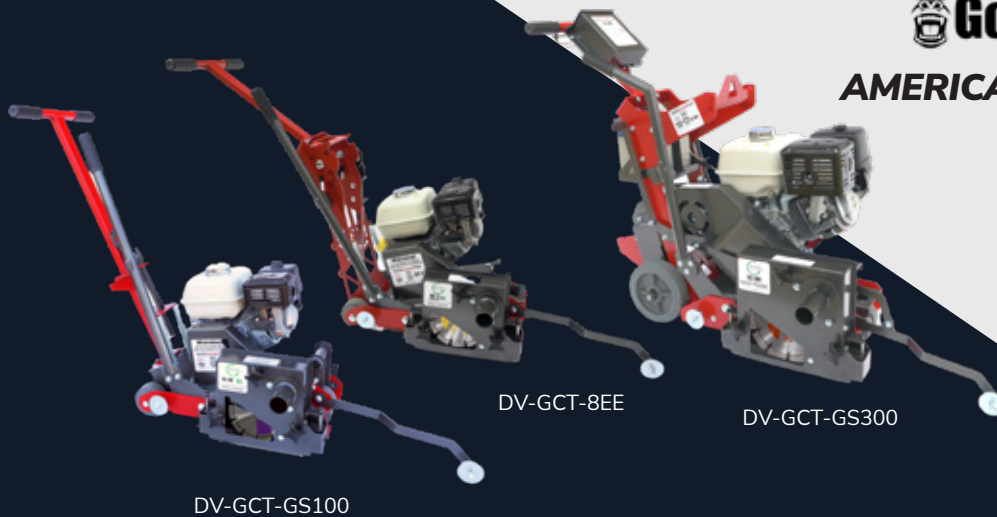

DV-GCT-GS100

DV-GCT-8EE

DV-GCT-GS300



- Made in Japan
- Professional Use for all Series!
- Multiple Speed Motor Drills
- SMD08: Single Speed
- SMD12 & SMD16: 2 Speed
- SMD24: 3 Speed
- Dry Core Bit is available with Special Swivel



SMD08

SMD12

SMD24



DRE5



DRE4

**EIBENSTOCK™**
**DRE5**

- Wet Use Only
- 3-speed oil bath gearbox - optimal lubrication
- 100% Aluminum housing

**DRE4**

- Wet drilling in reinforced concrete, natural stone and asphalt
- 3 speed 19.5 AMP hand-held core drill
- Wet and dry diamond core drill
- DRE4-S Stand sold separately

## HOW DIAMOND BLADES WORK

Diamond blades contain industrial-grade diamonds embedded in segments or rims on their cutting edge. As the blade is used, the abrasive qualities of the material being cut (such as concrete) wears down the segment. Diamond crystals either get crushed or let loose as the metal matrix gets worn away, exposing new diamonds to continue the cutting.

The abrasive quality of the material being cut is a large factor in choosing the correct blade for a job. Harder materials, such as cured concrete, require a blade with a softer metal mix. This softer mix will ensure adequate erosion of the segment bringing new diamond to the surface at the optimum rate.

Soft materials such as green concrete and asphalt tend to wear down segments faster. Therefore, segments with a harder, more wear-resistant metal mix in the segment, provide longer blade life and overall better performance.

Abrasive materials tend to erode the metal core, or center, of diamond blades causing undercutting. Undercutting is usually concentrated on part of the core that attaches to the segment. If undercutting is excessive, it can cause segment loss and damage the blade. Diamond Vantage® offers 3 types of undercut protection which reduce abrasive slurry accumulation beneath the segments to provide extended blade life.

Segments come in different heights. The total segment height is not as important as the diamond depth – the portion of the segment that contains diamonds. The diamond depth combined with diamond concentration and quality determines the overall performance value of the blade.

The accompanying chart shows the effect different variables have on a diamond blade cutting speed and blade life.

## WHAT TO CONSIDER WHEN CHOOSING A DIAMOND BLADE

### WHAT IS THE MATERIAL?

Ex.) Brick, block, combination, green concrete, cured concrete, asphalt etc.

### WHAT IS THE CUTTING METHOD

Wet and dry?

### WHAT KIND OF EQUIPMENT IS BEING USED?

Ex.) High speed hand held saw, masonry table type saw, walk behind saw (low or high HP), hand held power tool

### HOW DEEP IS THE CUT?

Use proper blade diameter for depth required. Remember, a 5” cut requires a 14” blade

### HOW BIG IS THE JOB?

Higher quality blades are more economical to use

DIAMOND BLADE CUTTING PERFORMANCE VARIABLES			
VARIABLES	CHANGE	RESULT	
		CUTTING SPEED	BLADE LIFE
Segment Bond Hardness	Harder Softer	Slower Faster	Longer Shorter
Segment Width	Thinner Thicker	Faster Slower	Shorter Longer
Material Hardness	Harder Softer	Slower Faster	Longer Shorter
Material Abrasiveness	More Less	Faster Slower	Shorter Longer
Material Steel Reinforcing	More Less	Faster Slower	Shorter Longer
Material Aggregate Size	Smaller Larger	Faster Slower	Shorter Longer
Horsepower	Lower Higher	Slower Faster	Longer Shorter
Blade Speed RPM	Lower Higher	Faster Slower	Shorter Longer
Water Volume	Lower Higher	Faster Slower	Shorter Longer
Cutting Pressure	Lower Higher	Faster Slower	Shorter Longer
Cutting Depth	Shallow Deep	Faster Slower	Longer Shorter



### AGGREGATE HARDNESS TO BOND RELATIONSHIP

	CRITICALLY HARD	HARD	MEDIUM	SOFT	GREEN
HARDNESS	8,000 PSI ex. power plants	6,000 - 8,000 PSI ex. bridges & airport runways	4,000 - 6,000 PSI ex. bridges & airport runways	2,000 - 4,000 PSI ex. patios & walks	> 2,000 PSI ex. concrete less than 48 hours old
AGGREGATE TYPE	flint, chert, basalt, trap rock, quartz	river rock, quartz, some granite, schist	some limestone, some granite, some marble, dolomite	sandstone, some limestone, some marble	can be any combination of rocks determined by end-product usage
AGGREGATE SIZES	Sieved Gravel + 1.5" ← RANGE →				Pea Gravel approx 0.25" diameter
SAND	round (low abrasion) ← RANGE →				Sharp (high abrasion)
STEEL REINFORCING	HEAVY - #4 rebar (1/2") - #5 rebar (5/8") - Multi mat wire mesh		MEDIUM - #4 rebar (1/2") - Multi mat wire mesh	LIGHT - Single mat wire mesh	
BOND HARDNESS SELECTION	SOFT BOND  HARD BOND				

### AGGREGATE MAP

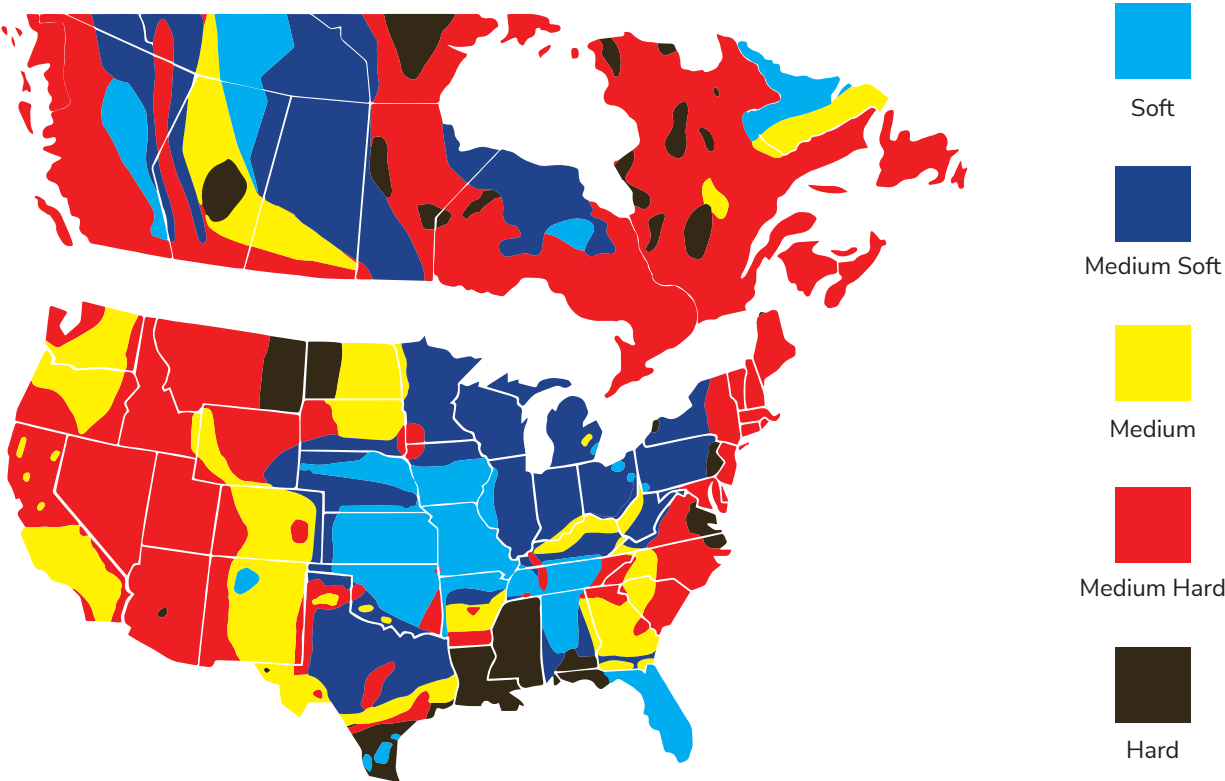

## DIAMOND BLADE CUTTING DEPTH AND SPEED

The actual cutting depth may vary depending on a number of factors, including the exact blade diameter, the exact flange diameter, saw components, etc.

Warning: Operating at greater than the max RPM can cause blade damage, which may cause injury.

Blade Size (in.)	Cutting Depth By Application (in.)					Speed	
	Flat Saw	Wall Saw	Masonry	High Speed	Tile	Rec. RPM	Max RPM
4	-	-	-	1	3/4	9,075	15,000
4 1/2	-	-	-	1 1/4	1	8,065	13,300
5	-	-	-	1 1/2	1 1/4	7,255	12,000
6	-	-	-	-	1 3/4	6,045	10,185
7	1 1/2	-	-	2 1/2	2 1/4	5,185	8,730
8	2	-	-	3	2 3/4	4,535	7,640
9	-	-	-	-	3 1/4	4,030	6,790
10	3	-	-	3 3/4	3 3/4	3,630	6,115
12	3 5/8	-	-	-	-	3,025	5,095
12HS	-	-	-	4	-	-	6,300
14	4 5/8	4 5/8	5	-	-	2,595	4,365
14HS	-	-	-	4 5/8	-	-	5,460
16	5 5/8	-	6	-	-	2,270	3,820
16HS	-	-	-	6	-	-	4,725
18	6 5/8	6 1/2	7	-	-	2,015	3,395
20	7 5/8	-	8-	-	-	1,815	3,055
20 5/8	-	-	8+	-	-	1,760	2,965
24	9 5/8	9 1/2	-	-	-	1,510	2,550
26	10 5/8	-	-	-	-	1,395	2,350
30	11 3/4	11 1/2	-	-	-	1,120	2,040
36	14 3/4	14 1/2	-	-	-	1,010	1,700
42	17 3/4	17 3/4	-	-	-	865	1,455
48	19 3/4	20 3/4	-	-	-	755	1,275

\* Rec. - Recommended  
 \*\*HS - High Speed Diamond Blades

## CORE BIT RPM CHART

OD (mm)	OD (in.)	RPM	
		Concrete/Masonry	Reinforced Concrete
		Feed Rate: 2-3 mm/s	Feed Rate: 1/2-1.8 mm/s
20	3/4	1900-2000	1150-1700
30	1 1/8	1300-1700	750-1150
40	1 1/2	950-1350	570-860
52	2	750-1100	440-660
62	2 1/2	620-950	370-550
72	2 7/8	550-800	320-480
82	3 1/4	475-700	280-420
107	4 1/4	360-550	220-340
122	4 7/8	320-480	190-280
142	5 1/2	270-400	160-240
162	6 1/4	240-350	140-210
182	7 1/8	210-320	120-190
212	8 1/4	180-270	110-160
250	11 7/8	150-230	100-140
300	11 7/8	130-190	80-120
400	15 3/4	100-140	60-90
500	19 3/4	70-120	45-70

OD - Outer Diameter



### DIAMOND BLADE SEGMENT/RIM SAMPLE CHART

Diamond blades come in many different segment and rim configurations. This chart may help to show the various types of products available and to simplify, for the user, the selection of what will best serve the desired application. The actual application will determine the final product specification, shape, and size.

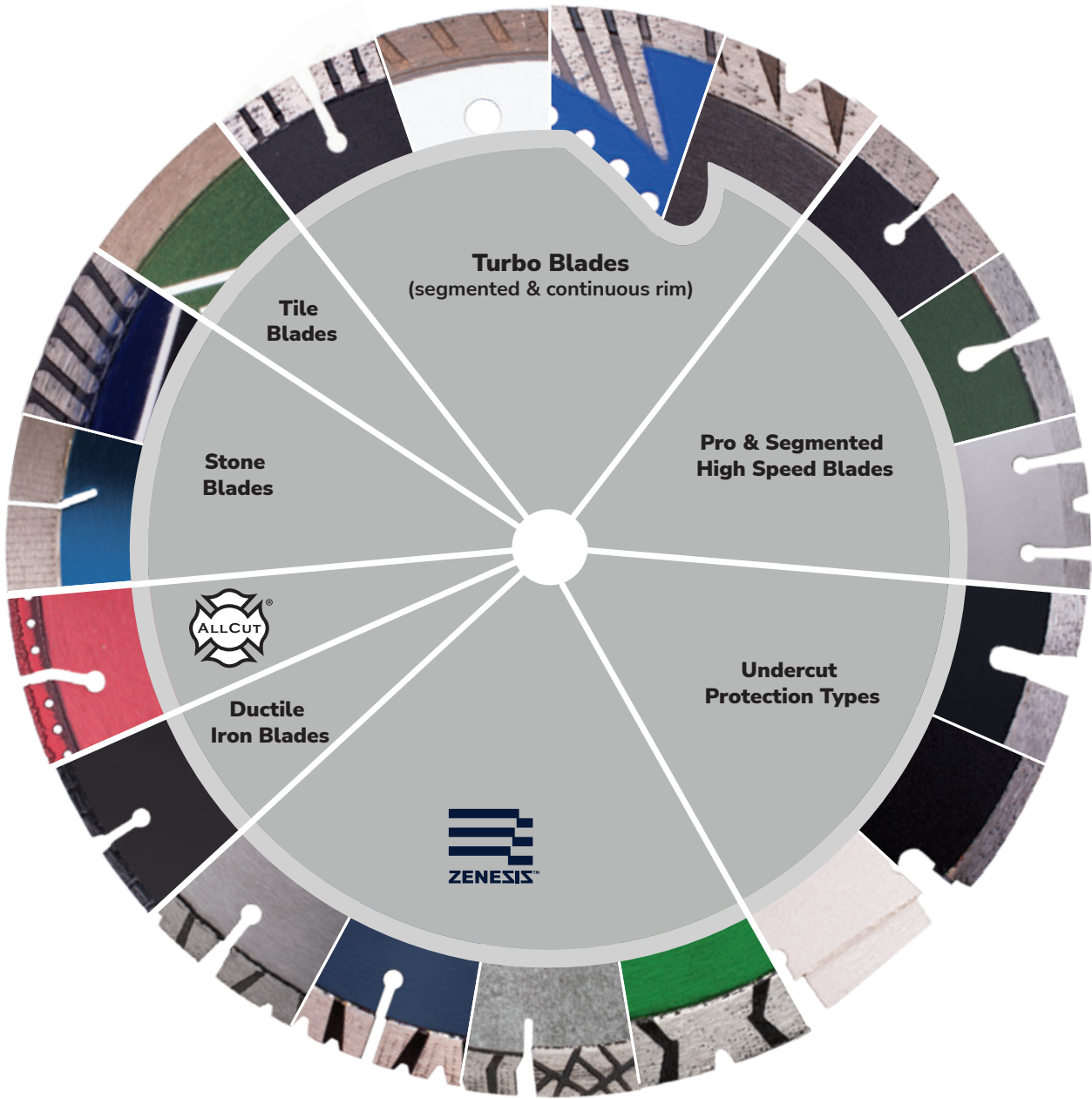



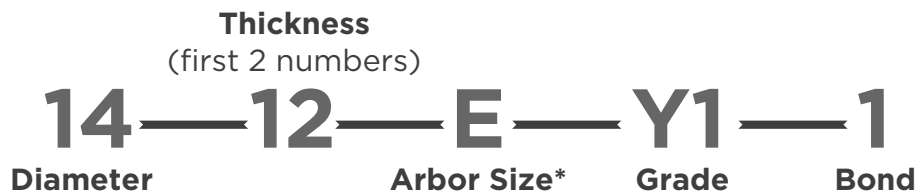















### PART NUMBER CHART



**\*Custom arbor sizes available by request**

Arbor	Segment/Rim	Application
A - 5/8"	W - Wet Cutting Only	C - Concrete
B - 20mm	D - Dry or Wet Cutting	O - Overlay
C - 7/8"-5/8"	Z - Turbo	G - Green Concrete
D - Diamond w/ 5/8" hole	ZG - ZZ Turbo Core Bit	A - Asphalt
E - 1"	K - Crown Bit	B - Brick/Block
H - 5/8"-11	V - Vortex	R - Refractories
J - 1 1/4"-7		DI - Ductile Iron
L - 60/50mm		T - Tile
U - Universal		S - Stone/Granite
BE - 20mm-1" Bushing		M - Marble
		U - Universal
		P - Tuck Pointing
		H - Hole Drilling
		L - Loop Sawing

### DESCRIPTION OF ICONS

							
angle grinder (small)	angle grinder (large)	bridge saw	CNC machine	circular saw	core drill	high hp walk-behind	low hp walk-behind
							
high speed saw	masonry saw	ring saw	tile saw	wall saw	chop saw	early entry saw	wet use
							
dry use	made in USA						

## BOND/SEGMENT HARDNESS

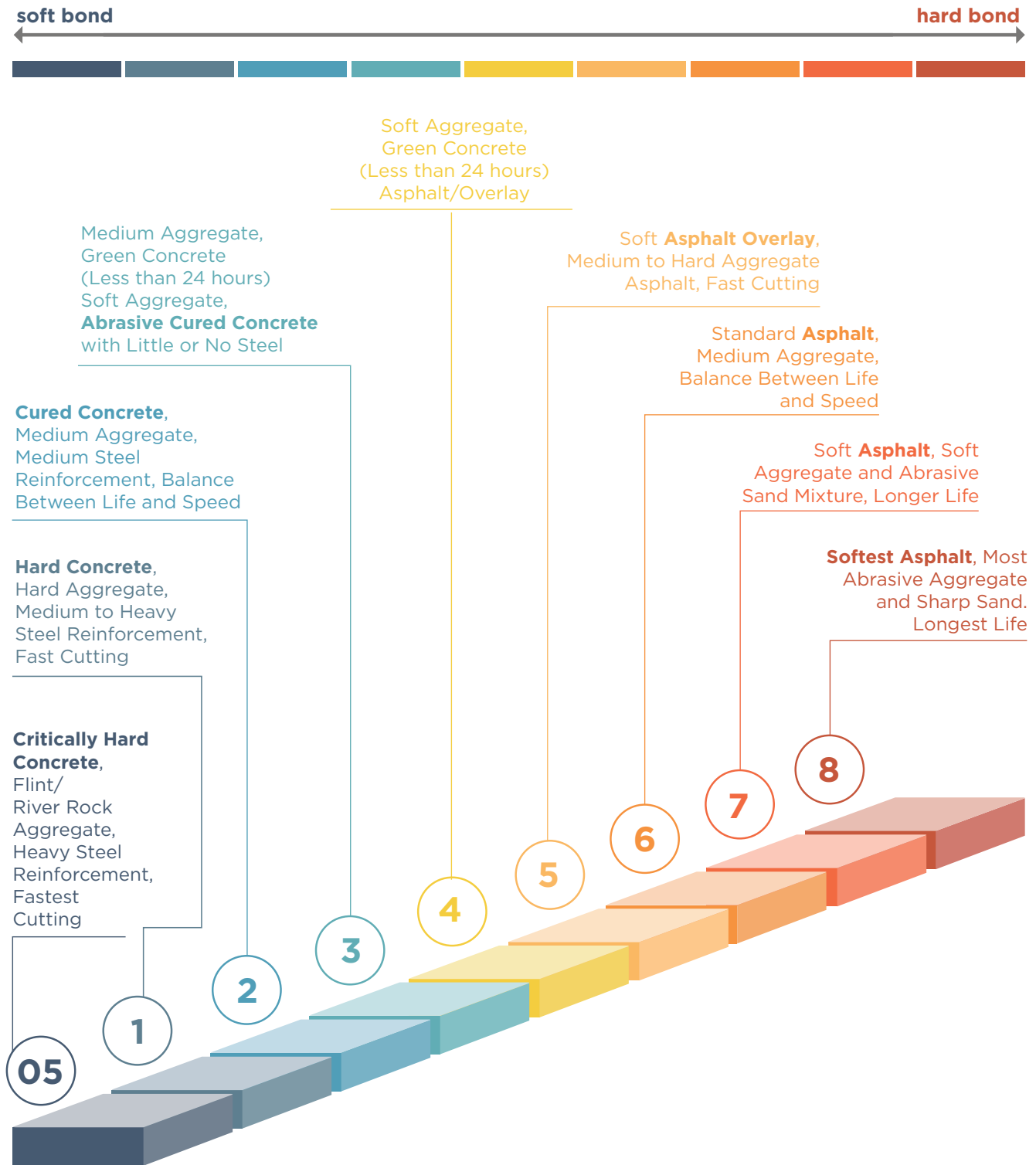



# PROFESSIONAL SERIES & SPECIALTY PRODUCTS

## PROSERIES PART NUMBER GUIDE

EXAMPLE: 1412EWCX32



## PROSERIES PERFORMANCE CHART

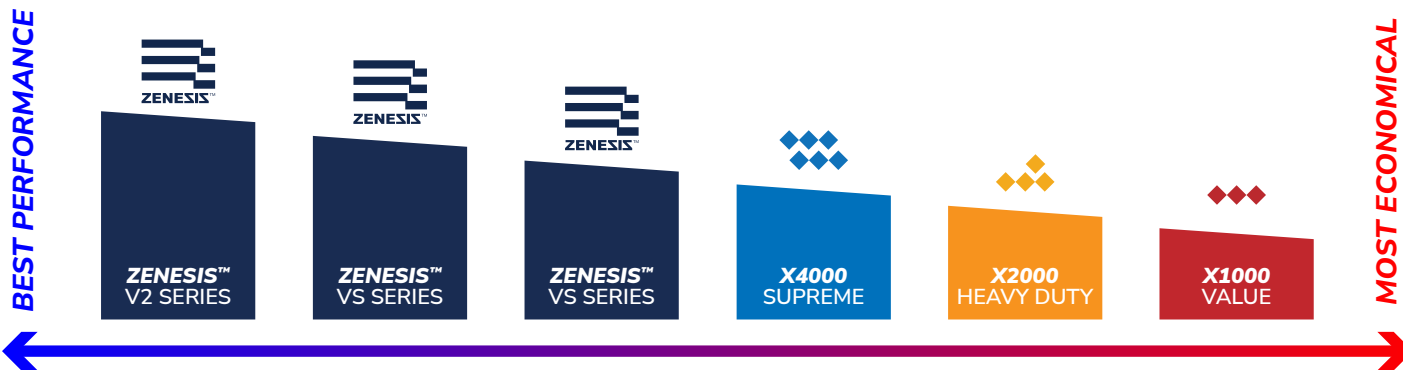

05	1	2	3	4	5	6	7	8
<b>Critically Hard Concrete,</b> Flint/River Rock Aggregate, Heavy Steel Reinforcement, Fastest Cutting	<b>Hard Concrete,</b> Hard Aggregate, Medium to Heavy Steel Reinforcement, Fast Cutting	<b>Cured Concrete,</b> Medium Aggregate, Medium Steel Reinforcement, Balance Between Life and Speed	Medium Aggregate, Green Concrete (Less than 24 hours) <b>Soft Aggregate, Abrasive Cured Concrete</b> with Little or No Steel	Soft Aggregate, Green Concrete (Less than 24 hours) Asphalt/Overlay	<b>Soft Asphalt Overlay,</b> Medium to Hard Aggregate Asphalt, Fast Cutting	Standard <b>Asphalt,</b> Medium Aggregate, Balance Between Life and Speed	Soft <b>Asphalt,</b> Soft Aggregate and Abrasive Sand Mixture, Longer Life	<b>Softest Asphalt,</b> Most Abrasive Aggregate and Sharp Sand, Longest Life



## FLAT SAW ARBOR CONFIGURATIONS

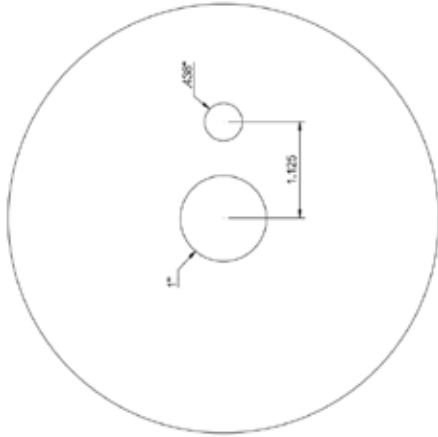

BASIC ARBOR CONFIGURATION

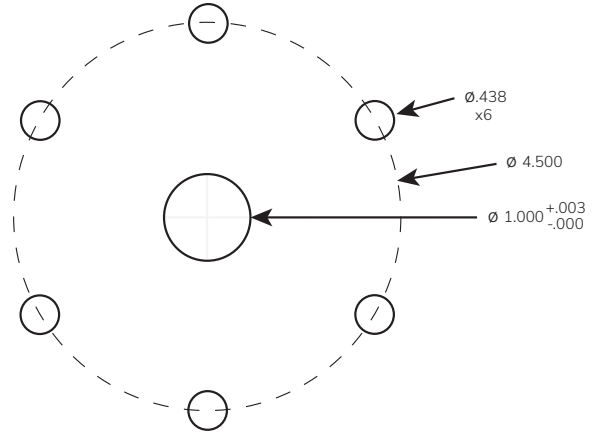

"GEORGE" ARBOR CONFIGURATION

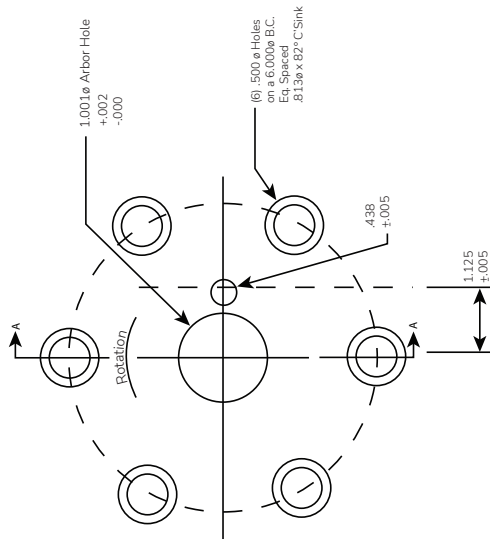

"ROGER" FLUSH CUT ARBOR CONFIGURATION

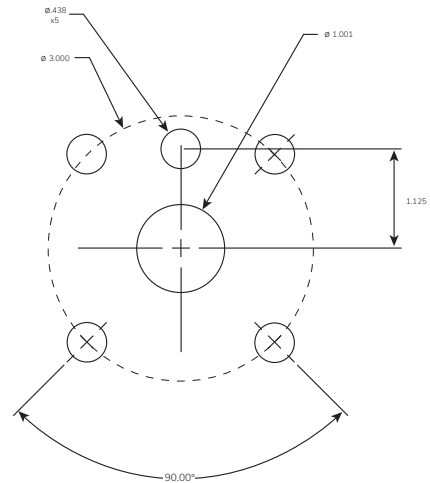

"LOUIE" ARBOR CONFIGURATION

## WALL SAW ARBOR CONFIGURATIONS

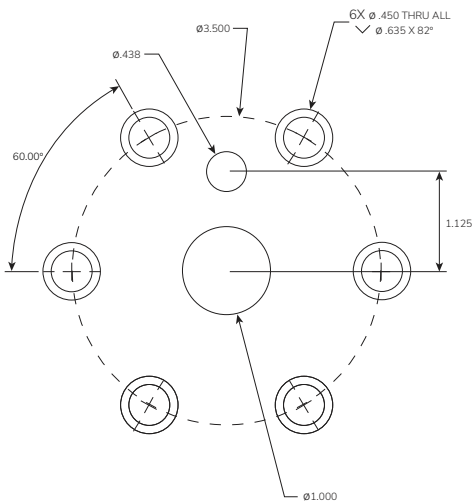

LONGYEAR ARBOR CONFIGURATION

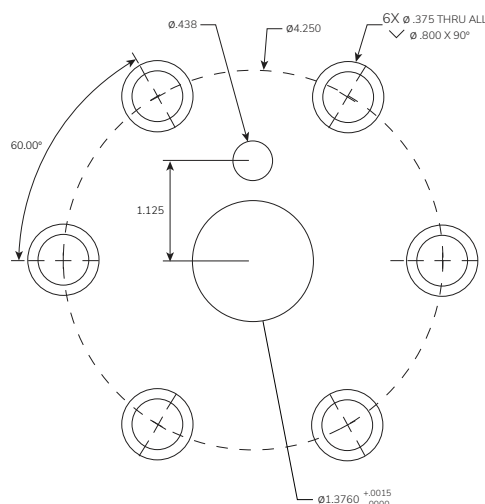

PENTRUDE<sup>®</sup> ARBOR SIZE: 1" OR 1 3/8" CONFIGURATION

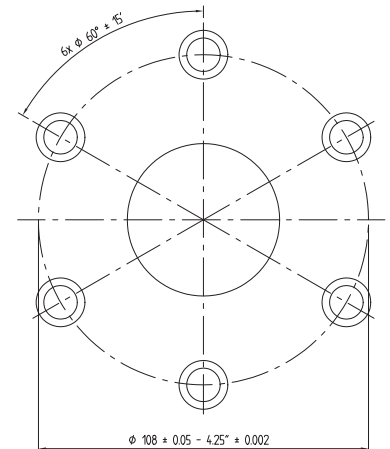

PENTRUDE<sup>®</sup> RS2<sup>®</sup> ARBOR CONFIGURATION

## ZENESIS™ V2 SERIES

CONCRETE

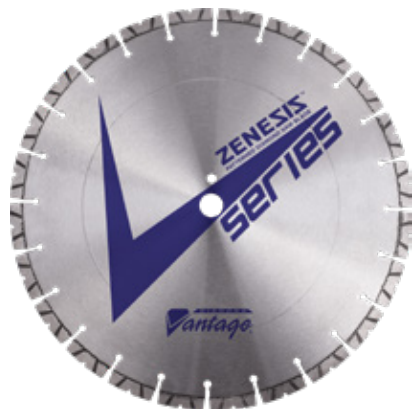

Size	Part #	List Price
12" x .125 x 1	1212EVRWZX4	\$817.90
12" x .155 x 1	1215EVRWZX4	\$1,022.71
12" x .187 x 1	1218EVRWZX4	\$1,138.66
12" x .250 x 1	1225EVRWZX4	\$1,419.64
14" x .125 x 1	1412EVRWZX4	\$957.69
14" x .140 x 1	1414EVRWZX4	\$1,008.78
14" x .155 x 1	1415EVRWZX4	\$1,142.28
14" x .165 x 1	1416EVRWZX4	\$1,201.58
14" x .187 x 1	1418EVRWZX4	\$1,265.37
14" x .250 x 1	1425EVRWZX4	\$1,592.33
16" x .125 x 1	1612EVRWZX4	\$1,150.66



## ZENESIS™ GRADE

- The new ZENESIS™ V2 series features a triangular structure and multi-diamond layers to control the exact time of diamond exposure, as well as the number of diamonds on the cut for uniform wear and optimum sawing performance. Field-test results have confirmed high cutting speed and long tool life on heavily reinforced concrete as well as overlay and other materials. A large selection of bond hardness and diamond concentrations are available to cover the majority of applications.

### APPLICATIONS - Concrete

Size	Part #	List Price
16" x .140 x 1	1614EVRWZX4	\$1,210.83
16" x .155 x 1	1615EVRWZX4	\$1,363.40
16" x .187 x 1	1618EVRWZX4	\$1,552.28
16" x .250 x 1	1625EVRWZX4	\$1,875.79
18" x .125 x 1	1812EVRWZX4	\$1,314.18
18" x .140 x 1	1814EVRWZX4	\$1,407.15
18" x .155 x 1	1815EVRWZX4	\$1,618.16
18" x .165 x 1	1816EVRWZX4	\$1,592.90
18" x .187 x 1	1818EVRWZX4	\$1,731.14
18" x .210 x 1	1821EVRWZX4	\$1,976.86
20" x .125 x 1	2012EVRWZX4	\$1,589.56
20" x .140 x 1	2014EVRWZX4	\$1,681.00
20" x .155 x 1	2015EVRWZX4	\$1,893.52
20" x .165 x 1	2016EVRWZX4	\$2,031.03
20" x .187 x 1	2018EVRWZX4	\$2,117.69
24" x .125 x 1	2412EVRWZX4	\$1,900.58
24" x .140 x 1	2414EVRWZX4	\$2,012.71
24" x .155 x 1	2415EVRWZX4	\$2,255.95
24" x .165 x 1	2416EVRWZX4	\$2,344.91
24" x .187 x 1	2418EVRWZX4	\$2,478.40
24" x .210 x 1	2421EVRWZX4	\$2,834.42
24" x .250 x 1	2425EVRWZX4	\$3,151.36
26" x .155 x 1	2615EVRWZX4	\$2,611.51
26" x .165 x 1	2616EVRWZX4	\$2,804.39

Size	Part #	List Price
26" x .187 x 1	2618EVRWZX4	\$3,076.42
28" x .175 x 1	2817EVRWZX4	\$3,146.51
30" x .155 x 1	3015EVRWZX4	\$3,117.60
30" x .165 x 1	3016EVRWZX4	\$3,357.23
30" x .175 x 1	3017EVRWZX4	\$3,335.87
30" x .187 x 1	3018EVRWZX4	\$3,588.25
30" x .210 x 1	3021EVRWZX4	\$3,837.88
30" x .250 x 1	3025EVRWZX4	\$4,408.91
36" x .155 x 1	3615EVRWZX4	\$3,921.97
36" x .165 x 1	3616EVRWZX4	\$4,055.46
36" x .175 x 1	3617EVRWZX4	\$4,216.42
36" x .187 x 1	3618EVRWZX4	\$4,595.04
36" x .210 x 1	3621EVRWZX4	\$4,995.51
36" x .250 x 1	3625EVRWZX4	\$5,508.38
42" x .187 x 1	4218EVRWZX4	\$5,914.76
42" x .210 x 1	4221EVRWZX4	\$5,975.11
42" x .250 x 1	4225EVRWZX4	\$6,413.71
48" x .187 x 1	4818EVRWZX4	\$6,681.64
48" x .210 x 1	4821EVRWZX4	\$7,196.53
48" x .250 x 1	4825EVRWZX4	\$8,134.09
54" x .187 x 1	5418EVRWZX4	\$8,532.65
54" x .210 x 1	5421EVRWZX4	\$9,488.23
60" x .210 x 1	6021EVRWZX4	\$11,094.38

## ZENESIS™ VS SERIES

CONCRETE



Size	Part #	List Price
12" x .125 x 1	1212EVSXZX4	\$628.44
12" x .155 x 1	1215EVSXZX4	\$772.04
12" x .187 x 1	1218EVSXZX4	\$966.07
12" x .250 x 1	1225EVSXZX4	\$1,154.85
14" x .125 x 1	1412EVSXZX4	\$718.74
14" x .140 x 1	1414EVSXZX4	\$781.47
14" x .155 x 1	1415EVSXZX4	\$888.36
14" x .165 x 1	1416EVSXZX4	\$990.48
14" x .187 x 1	1418EVSXZX4	\$1,092.21
14" x .250 x 1	1425EVSXZX4	\$1,228.67



## ZENESIS™ GRADE

- Features ZENESIS™, the most advanced diamond pattern for fast cutting through hard, reinforced concrete and long blade life
- All-new 12mm segments are tuned for the fastest, most aggressive cutting in hard aggregates
- Ideal for medium horsepower flat saws and electric/hydraulic saws

### APPLICATIONS - Concrete

Size	Part #	List Price
16" x .125 x 1	1612EVSXZX4	\$840.21
16" x .140 x 1	1614EVSXZX4	\$885.98
16" x .155 x 1	1615EVSXZX4	\$1,030.91
16" x .187 x 1	1618EVSXZX4	\$1,287.59
16" x .250 x 1	1625EVSXZX4	\$1,534.26
18" x .125 x 1	1812EVSXZX4	\$985.53
18" x .140 x 1	1814EVSXZX4	\$1,078.11
18" x .155 x 1	1815EVSXZX4	\$1,206.83
18" x .165 x 1	1816EVSXZX4	\$1,354.43
18" x .187 x 1	1818EVSXZX4	\$1,496.78
18" x .210 x 1	1821EVSXZX4	\$1,643.34
20" x .125 x 1	2012EVSXZX4	\$1,235.63
20" x .140 x 1	2014EVSXZX4	\$1,332.11
20" x .155 x 1	2015EVSXZX4	\$1,552.75
20" x .165 x 1	2016EVSXZX4	\$1,632.46
20" x .187 x 1	2018EVSXZX4	\$1,732.11
24" x .125 x 1	2412EVSXZX4	\$1,492.49
24" x .140 x 1	2414EVSXZX4	\$1,614.63
24" x .155 x 1	2415EVSXZX4	\$1,863.31
24" x .165 x 1	2416EVSXZX4	\$1,943.40
24" x .187 x 1	2418EVSXZX4	\$2,087.18
24" x .210 x 1	2421EVSXZX4	\$2,274.07
24" x .250 x 1	2425EVSXZX4	\$2,579.27
26" x .155 x 1	2615EVSXZX4	\$2,198.26

Size	Part #	List Price
26" x .165 x 1	2616EVSXZX4	\$2,284.08
26" x .187 x 1	2617EVSXZX4	\$2,431.95
28" x .175 x 1	2817EVSXZX4	\$2,715.62
30" x .155 x 1	3015EVSXZX4	\$2,659.08
30" x .165 x 1	3016EVSXZX4	\$2,756.35
30" x .175 x 1	3017EVSXZX4	\$2,884.29
30" x .187 x 1	3018EVSXZX4	\$2,923.19
30" x .210 x 1	3021EVSXZX4	\$3,178.64
30" x .250 x 1	3025EVSXZX4	\$3,638.98
36" x .155 x 1	3615EVSXZX4	\$3,366.37
36" x .165 x 1	3616EVSXZX4	\$3,486.52
36" x .175 x 1	3617EVSXZX4	\$3,673.01
36" x .187 x 1	3618EVSXZX4	\$3,721.07
36" x .210 x 1	3621EVSXZX4	\$3,937.33
36" x .250 x 1	3625EVSXZX4	\$4,614.39
42" x .187 x 1	4218EVSXZX4	\$4,869.36
42" x .210 x 1	4221EVSXZX4	\$5,106.20
42" x .250 x 1	4225EVSXZX4	\$5,714.52
48" x .187 x 1	4818EVSXZX4	\$5,480.53
48" x .210 x 1	4821EVSXZX4	\$5,758.58
48" x .250 x 1	4825EVSXZX4	\$6,741.43
54" x .187 x 1	5418EVSXZX4	\$7,106.99
54" x .210 x 1	5421EVSXZX4	\$7,767.96
60" x .210 x 1	6021EVSXZX4	\$9,107.03

**ZENESIS™ V SERIES**  
CONCRETE



Size	Part #	List Price
12" x .125 x 1	1212EWWZX4	\$709.77
12" x .155 x 1	1215EWWZX4	\$821.62
12" x .187 x 1	1218EWWZX4	\$994.20
12" x .250 x 1	1225EWWZX4	\$1,151.67
14" x .125 x 1	1412EWWZX4	\$813.61
14" x .140 x 1	1414EWWZX4	\$879.59
14" x .155 x 1	1415EWWZX4	\$946.14
14" x .165 x 1	1416EWWZX4	\$1,018.33
14" x .187 x 1	1418EWWZX4	\$1,125.02
14" x .250 x 1	1425EWWZX4	\$1,398.95
16" x .125 x 1	1612EWWZX4	\$948.61

**ZENESIS™ GRADE**

- Features ZENESIS™, the most advance diamond pattern for fast cutting through hard, reinforced concrete and long blade life
- All-new 12mm segments are tuned for aggressive performance in hard aggregates
- Ideal for medium to high horsepower flat saws

**APPLICATIONS - Concrete**

Size	Part #	List Price
16" x .140 x 1	1614EWWZX4	\$998.11
16" x .155 x 1	1615EWWZX4	\$1,096.99
16" x .187 x 1	1618EWWZX4	\$1,325.06
16" x .250 x 1	1625EWWZX4	\$1,581.64
18" x .125 x 1	1812EWWZX4	\$1,107.46
18" x .140 x 1	1814EWWZX4	\$1,204.25
18" x .155 x 1	1815EWWZX4	\$1,281.10
18" x .165 x 1	1816EWWZX4	\$1,390.28
18" x .187 x 1	1818EWWZX4	\$1,539.02
18" x .210 x 1	1821EWWZX4	\$1,689.09
20" x .125 x 1	2012EWWZX4	\$1,266.42
20" x .140 x 1	2014EWWZX4	\$1,365.20
20" x .155 x 1	2015EWWZX4	\$1,565.33
20" x .165 x 1	2016EWWZX4	\$1,634.38
20" x .187 x 1	2018EWWZX4	\$1,775.30
24" x .125 x 1	2412EWWZX4	\$1,528.34
24" x .140 x 1	2414EWWZX4	\$1,653.25
24" x .155 x 1	2415EWWZX4	\$1,884.95
24" x .165 x 1	2416EWWZX4	\$1,945.88
24" x .187 x 1	2418EWWZX4	\$2,137.61
24" x .210 x 1	2421EWWZX4	\$2,332.90
24" x .250 x 1	2425EWWZX4	\$2,651.64
26" x .155 x 1	2615EWWZX4	\$2,467.24
26" x .165 x 1	2616EWWZX4	\$2,540.85

Size	Part #	List Price
26" x .187 x 1	2618EWWZX4	\$2,762.25
28" x .175 x 1	2817EWWZX4	\$3,081.37
30" x .155 x 1	3015EWWZX4	\$2,982.50
30" x .165 x 1	3016EWWZX4	\$3,066.03
30" x .175 x 1	3017EWWZX4	\$3,271.51
30" x .187 x 1	3018EWWZX4	\$3,316.03
30" x .210 x 1	3021EWWZX4	\$3,611.23
30" x .250 x 1	3025EWWZX4	\$4,141.94
36" x .155 x 1	3615EWWZX4	\$3,774.95
36" x .165 x 1	3616EWWZX4	\$3,878.11
36" x .175 x 1	3617EWWZX4	\$4,164.54
36" x .187 x 1	3618EWWZX4	\$4,218.60
36" x .210 x 1	3621EWWZX4	\$4,472.89
36" x .250 x 1	3625EWWZX4	\$5,247.70
42" x .187 x 1	4218EWWZX4	\$5,502.47
42" x .210 x 1	4221EWWZX4	\$5,780.98
42" x .250 x 1	4225EWWZX4	\$6,481.60
48" x .187 x 1	4818EWWZX4	\$6,197.56
48" x .210 x 1	4821EWWZX4	\$6,524.61
48" x .250 x 1	4825EWWZX4	\$7,645.52
54" x .187 x 1	5418EWWZX4	\$8,012.71
54" x .210 x 1	5421EWWZX4	\$8,766.53
60" x .210 x 1	6021EWWZX4	\$10,273.14

**X4000**  
CONCRETE

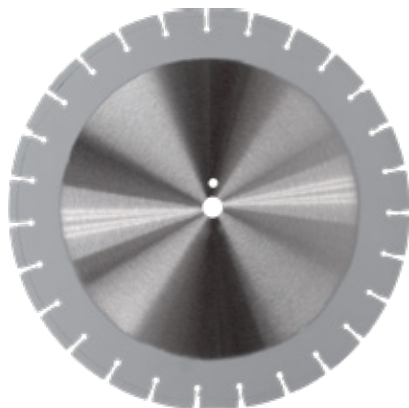

Size	Part #	List Price
12" x .125 x 1	1212EWCX4	\$782.81
12" x .155 x 1	1215EWCX4	\$904.29
12" x .187 x 1	1218EWCX4	\$1,041.20
12" x .250 x 1	1225EWCX4	\$1,300.46
12" x .375 x 1	1237EWCX4	\$1,802.10
12" x .500 x 1	1250EWCX4	\$2,564.88
14" x .125 x 1	1412EWCX4	\$898.75
14" x .140 x 1	1414EWCX4	\$990.00
14" x .155 x 1	1415EWCX4	\$1,058.57
14" x .165 x 1	1416EWCX4	\$1,110.14
14" x .187 x 1	1418EWCX4	\$1,214.56

**SUPREME GRADE**

- 12mm (.472") segment height
- Utilizes our highest quality diamond for maximum performance
- Highly recommended for machines 65HP and larger

**APPLICATIONS - Concrete**

Size	Part #	List Price
14" x .250 x 1	1425EWCX4	\$1,527.29
14" x .310 x 1	1431EWCX4	\$1,954.64
14" x .375 x 1	1437EWCX4	\$2,119.59
14" x .500 x 1	1450EWCX4	\$2,755.57
16" x .125 x 1	1612EWCX4	\$1,045.88
16" x .140 x 1	1614EWCX4	\$1,154.76
16" x .155 x 1	1615EWCX4	\$1,233.15
16" x .187 x 1	1618EWCX4	\$1,420.03
16" x .250 x 1	1625EWCX4	\$1,743.64
16" x .375 x 1	1637EWCX4	\$2,474.97
18" x .125 x 1	1812EWCX4	\$1,216.94
18" x .140 x 1	1814EWCX4	\$1,346.23
18" x .155 x 1	1815EWCX4	\$1,434.42
18" x .165 x 1	1816EWCX4	\$1,494.68
18" x .187 x 1	1818EWCX4	\$1,657.44
18" x .210 x 1	1821EWCX4	\$1,799.14
18" x .250 x 1	1825EWCX4	\$2,039.50
18" x .375 x 1	1837EWCX4	\$2,794.75
20" x .125 x 1	2012EWCX4	\$1,421.84
20" x .140 x 1	2014EWCX4	\$1,537.30
20" x .155 x 1	2015EWCX4	\$1,660.30
20" x .165 x 1	2016EWCX4	\$1,720.28
20" x .187 x 1	2018EWCX4	\$1,896.20
24" x .125 x 1	2412EWCX4	\$1,709.70
24" x .140 x 1	2414EWCX4	\$1,854.06
24" x .155 x 1	2415EWCX4	\$1,988.68
24" x .165 x 1	2416EWCX4	\$2,045.80

Size	Part #	List Price
24" x .187 x 1	2418EWCX4	\$2,276.92
24" x .210 x 1	2421EWCX4	\$2,490.98
24" x .250 x 1	2425EWCX4	\$2,824.03
26" x .155 x 1	2615EWCX4	\$2,475.73
26" x .165 x 1	2616EWCX4	\$2,536.94
26" x .187 x 1	2618EWCX4	\$2,778.27
30" x .155 x 1	3015EWCX4	\$2,973.54
30" x .165 x 1	3016EWCX4	\$3,042.85
30" x .175 x 1	3017EWCX4	\$3,211.62
30" x .187 x 1	3018EWCX4	\$3,315.65
30" x .210 x 1	3021EWCX4	\$3,573.66
30" x .250 x 1	3025EWCX4	\$3,999.02
36" x .175 x 1	3617EWCX4	\$4,077.40
36" x .187 x 1	3618EWCX4	\$4,206.02
36" x .210 x 1	3621EWCX4	\$4,532.30
36" x .250 x 1	3625EWCX4	\$5,085.60
42" x .187 x 1	4218EWCX4	\$5,324.07
42" x .210 x 1	4221EWCX4	\$5,700.79
42" x .250 x 1	4225EWCX4	\$6,275.17
48" x .187 x 1	4818EWCX4	\$6,103.94
48" x .210 x 1	4821EWCX4	\$6,643.70
48" x .250 x 1	4825EWCX4	\$7,365.77
54" x .187 x 1	5418EWCX4	\$7,966.85
54" x .210 x 1	5421EWCX4	\$8,496.80
60" x .210 x 1	6021EWCX4	\$9,750.63
60" x .250 x 1	6025EWCX4	\$10,601.71

PLEASE CALL FOR ADDITIONAL SIZES



**X2000**  
CONCRETE

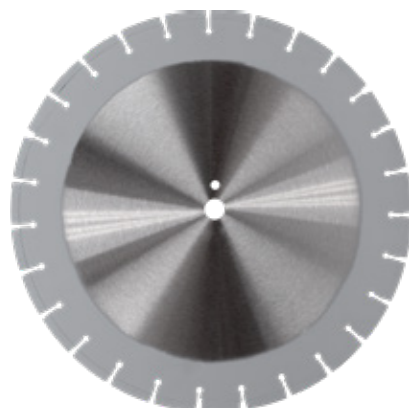

Size	Part #	List Price
12" x .125 x 1	1212EWCX1	\$645.56
12" x .155 x 1	1215EWCX1	\$786.89
12" x .187 x 1	1218EWCX1	\$892.13
12" x .250 x 1	1225EWCX1	\$1,087.89
12" x .375 x 1	1237EWCX1	\$1,259.59
12" x .500 x 1	1250EWCX1	\$1,812.65
14" x .125 x 1	1412EWCX1	\$738.78
14" x .140 x 1	1414EWCX1	\$861.53
14" x .155 x 1	1415EWCX1	\$921.68
14" x .165 x 1	1416EWCX1	\$959.06
14" x .187 x 1	1418EWCX1	\$1,040.59

**STANDARD PLUS**

- 10mm (.394") segment height
- Balance between cost and performance (not for machines over 65HP)

APPLICATIONS - Concrete

Size	Part #	List Price
14" x .250 x 1	1425EWCX1	\$1,279.33
14" x .310 x 1	1431EWCX1	\$1,690.48
14" x .375 x 1	1437EWCX1	\$1,723.65
14" x .500 x 1	1450EWCX1	\$2,124.05
16" x .125 x 1	1612EWCX1	\$863.05
16" x .140 x 1	1614EWCX1	\$1,008.00
16" x .155 x 1	1615EWCX1	\$1,076.68
16" x .187 x 1	1618EWCX1	\$1,221.28
16" x .250 x 1	1625EWCX1	\$1,460.26
16" x .375 x 1	1637EWCX1	\$2,022.43
18" x .125 x 1	1812EWCX1	\$1,011.27
18" x .140 x 1	1814EWCX1	\$1,181.11
18" x .155 x 1	1815EWCX1	\$1,258.31
18" x .165 x 1	1816EWCX1	\$1,300.36
18" x .187 x 1	1818EWCX1	\$1,433.86
18" x .210 x 1	1821EWCX1	\$1,546.35
18" x .250 x 1	1825EWCX1	\$1,720.85
18" x .375 x 1	1837EWCX1	\$2,285.82
20" x .125 x 1	2012EWCX1	\$1,201.31
20" x .140 x 1	2014EWCX1	\$1,287.51
20" x .155 x 1	2015EWCX1	\$1,415.40
20" x .165 x 1	2016EWCX1	\$1,460.84
20" x .187 x 1	2018EWCX1	\$1,627.17
24" x .125 x 1	2412EWCX1	\$1,452.44
24" x .140 x 1	2414EWCX1	\$1,562.57
24" x .155 x 1	2415EWCX1	\$1,703.09
24" x .165 x 1	2416EWCX1	\$1,743.15

Size	Part #	List Price
24" x .187 x 1	2418EWCX1	\$1,963.09
24" x .210 x 1	2421EWCX1	\$2,165.97
24" x .250 x 1	2425EWCX1	\$2,453.66
26" x .155 x 1	2615EWCX1	\$2,169.72
26" x .165 x 1	2616EWCX1	\$2,212.58
26" x .187 x 1	2618EWCX1	\$2,441.98
30" x .155 x 1	3015EWCX1	\$2,626.64
30" x .165 x 1	3016EWCX1	\$2,675.23
30" x .175 x 1	3017EWCX1	\$2,788.65
30" x .187 x 1	3018EWCX1	\$2,934.53
30" x .210 x 1	3021EWCX1	\$3,178.89
30" x .250 x 1	3025EWCX1	\$3,549.15
36" x .175 x 1	3617EWCX1	\$3,554.87
36" x .187 x 1	3618EWCX1	\$3,735.09
36" x .210 x 1	3621EWCX1	\$4,044.74
36" x .250 x 1	3625EWCX1	\$4,529.82
42" x .187 x 1	4218EWCX1	\$4,808.39
42" x .210 x 1	4221EWCX1	\$5,166.74
42" x .250 x 1	4225EWCX1	\$5,666.53
48" x .187 x 1	4818EWCX1	\$5,498.57
48" x .210 x 1	4821EWCX1	\$6,016.71
48" x .250 x 1	4825EWCX1	\$6,651.30
54" x .187 x 1	5418EWCX1	\$7,294.17
54" x .210 x 1	5421EWCX1	\$7,800.04
60" x .210 x 1	6021EWCX1	\$8,984.30
60" x .250 x 1	6025EWCX1	\$9,728.44

**X1000**  
CONCRETE

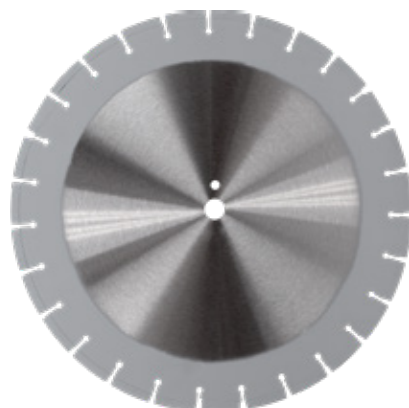

Size	Part #	List Price
12" x .125 x 1	1212EWCX0	\$525.50
12" x .155 x 1	1215EWCX0	\$623.84
12" x .187 x 1	1218EWCX0	\$703.39
12" x .250 x 1	1225EWCX0	\$830.46
12" x .375 x 1	1237EWCX0	\$933.49
12" x .500 x 1	1250EWCX0	\$1,279.68
14" x .125 x 1	1412EWCX0	\$598.62
14" x .140 x 1	1414EWCX0	\$681.77
14" x .165 x 1	1416EWCX0	\$764.81
14" x .187 x 1	1418EWCX0	\$820.41

**STANDARD GRADE**

- 10mm (.394") segment height
- Most economical version of our professional series blades (not for machines over 65HP)

APPLICATIONS - Concrete

Size	Part #	List Price
14" x .250 x 1	1425EWCX0	\$979.04
14" x .375 x 1	1437EWCX0	\$1,263.09
14" x .500 x 1	1450EWCX0	\$1,503.36
16" x .125 x 1	1612EWCX0	\$702.91
16" x .140 x 1	1614EWCX0	\$801.85
16" x .155 x 1	1615EWCX0	\$859.31
16" x .187 x 1	1618EWCX0	\$969.46
16" x .250 x 1	1625EWCX0	\$1,116.98
16" x .375 x 1	1637EWCX0	\$1,496.12
18" x .125 x 1	1812EWCX0	\$831.05
18" x .140 x 1	1814EWCX0	\$949.71
18" x .155 x 1	1815EWCX0	\$1,013.73
18" x .165 x 1	1816EWCX0	\$1,050.64
18" x .187 x 1	1818EWCX0	\$1,150.61
18" x .210 x 1	1821EWCX0	\$1,211.70
18" x .250 x 1	1825EWCX0	\$1,334.70
18" x .375 x 1	1837EWCX0	\$1,693.63
20" x .125 x 1	2012EWCX0	\$961.04
20" x .140 x 1	2014EWCX0	\$1,047.25
20" x .155 x 1	2015EWCX0	\$1,140.80
20" x .165 x 1	2016EWCX0	\$1,186.24
20" x .187 x 1	2018EWCX0	\$1,283.89
24" x .125 x 1	2412EWCX0	\$1,172.11
24" x .140 x 1	2414EWCX0	\$1,282.25
24" x .155 x 1	2415EWCX0	\$1,382.70
24" x .165 x 1	2416EWCX0	\$1,422.76
24" x .187 x 1	2418EWCX0	\$1,562.57

Size	Part #	List Price
24" x .210 x 1	2421EWCX0	\$1,725.40
24" x .250 x 1	2425EWCX0	\$1,893.01
26" x .155 x 1	2615EWCX0	\$1,683.35
26" x .165 x 1	2616EWCX0	\$1,726.33
26" x .187 x 1	2618EWCX0	\$1,869.89
30" x .155 x 1	3015EWCX0	\$2,075.57
30" x .165 x 1	3016EWCX0	\$2,124.16
30" x .175 x 1	3017EWCX0	\$2,286.17
30" x .187 x 1	3018EWCX0	\$2,314.78
30" x .210 x 1	3021EWCX0	\$2,481.93
30" x .250 x 1	3025EWCX0	\$2,706.30
36" x .175 x 1	3617EWCX0	\$2,934.18
36" x .187 x 1	3618EWCX0	\$3,029.49
36" x .210 x 1	3621EWCX0	\$3,183.67
36" x .250 x 1	3625EWCX0	\$3,488.64
42" x .187 x 1	4218EWCX0	\$4,007.48
42" x .210 x 1	4221EWCX0	\$4,300.07
42" x .250 x 1	4225EWCX0	\$4,602.46
48" x .187 x 1	4818EWCX0	\$4,468.84
48" x .210 x 1	4821EWCX0	\$4,909.65
48" x .250 x 1	4825EWCX0	\$5,312.62
54" x .187 x 1	5418EWCX0	\$6,149.98
54" x .210 x 1	5421EWCX0	\$6,570.11
60" x .210 x 1	6021EWCX0	\$7,631.38
60" x .250 x 1	6025EWCX0	\$9,296.51

**X4000**  
ASPHALT

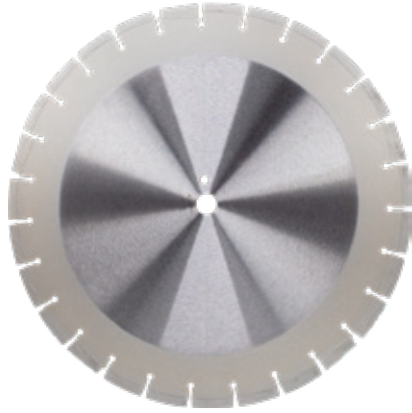

Size	Part #	List Price
12" x .125 x 1	1212EWAX4	\$819.04
12" x .155 x 1	1215EWAX4	\$947.48
12" x .187 x 1	1218EWAX4	\$1,092.98
12" x .250 x 1	1225EWAX4	\$1,221.51
12" x .375 x 1	1237EWAX4	\$1,954.64
12" x .500 x 1	1250EWAX4	\$2,336.04
14" x .125 x 1	1412EWAX4	\$939.47
14" x .140 x 1	1414EWAX4	\$1,038.82
14" x .155 x 1	1415EWAX4	\$1,116.91
14" x .165 x 1	1416EWAX4	\$1,157.62
14" x .187 x 1	1418EWAX4	\$1,274.91

**SUPREME GRADE**

- 10mm (.394") segment height
- Utilizes our highest quality diamond for maximum performance in cutting asphalt
- Highly recommended for machines 65HP and larger
- Offers user the lowest cost per cut

**APPLICATIONS - Asphalt**

Size	Part #	List Price
14" x .250 x 1	1425EWAX4	\$1,441.57
14" x .310 x 1	1431EWAX4	\$2,049.99
14" x .375 x 1	1437EWAX4	\$2,288.37
14" x .500 x 1	1450EWAX4	\$2,755.57
16" x .125 x 1	1612EWAX4	\$1,094.59
16" x .140 x 1	1614EWAX4	\$1,213.21
16" x .155 x 1	1615EWAX4	\$1,293.78
16" x .187 x 1	1618EWAX4	\$1,492.49
16" x .250 x 1	1625EWAX4	\$1,597.09
18" x .125 x 1	1812EWAX4	\$1,276.15
18" x .140 x 1	1814EWAX4	\$1,417.26
18" x .155 x 1	1815EWAX4	\$1,507.85
18" x .165 x 1	1816EWAX4	\$1,578.31
18" x .187 x 1	1818EWAX4	\$1,745.74
18" x .210 x 1	1821EWAX4	\$1,689.48
18" x .250 x 1	1825EWAX4	\$1,883.42
20" x .125 x 1	2012EWAX4	\$1,519.10
20" x .140 x 1	2014EWAX4	\$1,675.18
20" x .155 x 1	2015EWAX4	\$1,826.96
20" x .165 x 1	2016EWAX4	\$1,885.32
20" x .187 x 1	2018EWAX4	\$2,055.81
24" x .125 x 1	2412EWAX4	\$1,865.92
24" x .140 x 1	2414EWAX4	\$2,021.73
24" x .155 x 1	2415EWAX4	\$2,188.87
24" x .165 x 1	2416EWAX4	\$2,242.71
24" x .187 x 1	2418EWAX4	\$2,470.25

Size	Part #	List Price
24" x .210 x 1	2421EWAX4	\$2,403.79
24" x .250 x 1	2425EWAX4	\$2,717.28
26" x .155 x 1	2615EWAX4	\$2,728.61
26" x .165 x 1	2616EWAX4	\$2,786.19
26" x .187 x 1	2618EWAX4	\$3,023.19
30" x .155 x 1	3015EWAX4	\$3,278.75
30" x .165 x 1	3016EWAX4	\$3,344.04
30" x .175 x 1	3017EWAX4	\$3,546.46
30" x .187 x 1	3018EWAX4	\$3,611.76
30" x .210 x 1	3021EWAX4	\$3,718.62
30" x .250 x 1	3025EWAX4	\$3,932.61
36" x .175 x 1	3617EWAX4	\$4,503.31
36" x .187 x 1	3618EWAX4	\$4,584.01
36" x .210 x 1	3621EWAX4	\$4,512.17
36" x .250 x 1	3625EWAX4	\$5,019.80
42" x .187 x 1	4218EWAX4	\$5,902.71
42" x .210 x 1	4221EWAX4	\$5,904.34
42" x .250 x 1	4225EWAX4	\$6,388.60
48" x .187 x 1	4818EWAX4	\$6,667.30
48" x .210 x 1	4821EWAX4	\$6,764.36
48" x .250 x 1	4825EWAX4	\$7,373.13
54" x .187 x 1	5418EWAX4	\$8,501.90
54" x .210 x 1	5421EWAX4	\$8,660.75
60" x .210 x 1	6021EWAX4	\$9,976.06
60" x .250 x 1	6025EWAX4	\$13,301.17

**X2000**  
ASPHALT

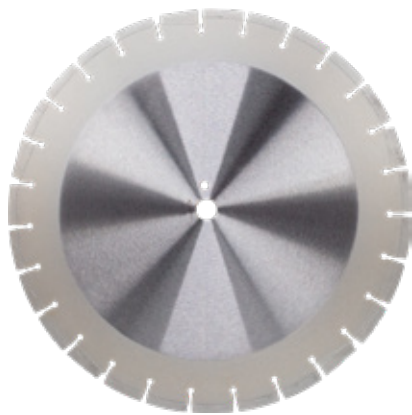

Size	Part #	List Price
12" x .125 x 1	1212EWAX2	\$727.10
12" x .155 x 1	1215EWAX2	\$843.42
12" x .187 x 1	1218EWAX2	\$972.26
12" x .250 x 1	1225EWAX2	\$1,065.00
12" x .375 x 1	1237EWAX2	\$1,202.36
12" x .500 x 1	1250EWAX2	\$2,097.65
14" x .125 x 1	1412EWAX2	\$833.85
14" x .140 x 1	1414EWAX2	\$921.68
14" x .155 x 1	1415EWAX2	\$994.34
14" x .165 x 1	1416EWAX2	\$1,018.51

**HEAVY DUTY GRADE**

- 10mm (.394") segment height
- Balance between cost and performance (not for machines over 65HP)

**APPLICATIONS - Asphalt**

Size	Part #	List Price
14" x .187 x 1	1418EWAX2	\$1,134.03
14" x .250 x 1	1425EWAX2	\$1,219.30
14" x .310 x 1	1431EWAX2	\$1,668.64
14" x .375 x 1	1437EWAX2	\$1,706.72
14" x .500 x 1	1450EWAX2	\$2,240.73
16" x .125 x 1	1612EWAX2	\$971.79
16" x .140 x 1	1614EWAX2	\$1,076.68
16" x .155 x 1	1615EWAX2	\$1,152.02
16" x .187 x 1	1618EWAX2	\$1,328.04
16" x .250 x 1	1625EWAX2	\$1,391.58
18" x .125 x 1	1812EWAX2	\$1,133.44
18" x .140 x 1	1814EWAX2	\$1,258.31
18" x .155 x 1	1815EWAX2	\$1,343.11
18" x .165 x 1	1816EWAX2	\$1,390.41
18" x .187 x 1	1818EWAX2	\$1,553.93
18" x .210 x 1	1821EWAX2	\$1,569.24
18" x .250 x 1	1825EWAX2	\$1,643.64
20" x .125 x 1	2012EWAX2	\$1,344.28
20" x .140 x 1	2014EWAX2	\$1,489.11
20" x .155 x 1	2015EWAX2	\$1,625.65
20" x .165 x 1	2016EWAX2	\$1,678.21
20" x .187 x 1	2018EWAX2	\$1,831.69
24" x .125 x 1	2412EWAX2	\$1,652.63
24" x .140 x 1	2414EWAX2	\$1,797.82
24" x .155 x 1	2415EWAX2	\$1,948.37
24" x .165 x 1	2416EWAX2	\$1,996.85
24" x .187 x 1	2418EWAX2	\$2,201.60

Size	Part #	List Price
24" x .210 x 1	2421EWAX2	\$2,130.82
24" x .250 x 1	2425EWAX2	\$2,340.95
26" x .155 x 1	2615EWAX2	\$2,432.52
26" x .165 x 1	2616EWAX2	\$2,484.27
26" x .187 x 1	2618EWAX2	\$2,697.66
30" x .155 x 1	3015EWAX2	\$2,924.48
30" x .165 x 1	3016EWAX2	\$2,983.24
30" x .175 x 1	3017EWAX2	\$3,139.17
30" x .187 x 1	3018EWAX2	\$3,224.20
30" x .210 x 1	3021EWAX2	\$3,136.25
30" x .250 x 1	3025EWAX2	\$3,412.38
36" x .175 x 1	3617EWAX2	\$3,987.97
36" x .187 x 1	3618EWAX2	\$4,092.98
36" x .210 x 1	3621EWAX2	\$4,062.26
36" x .250 x 1	3625EWAX2	\$4,360.92
42" x .187 x 1	4218EWAX2	\$5,276.65
42" x .210 x 1	4221EWAX2	\$5,260.52
42" x .250 x 1	4225EWAX2	\$5,577.76
48" x .187 x 1	4818EWAX2	\$5,958.77
48" x .210 x 1	4821EWAX2	\$6,025.11
48" x .250 x 1	4825EWAX2	\$6,434.04
54" x .187 x 1	5418EWAX2	\$7,605.33
54" x .210 x 1	5421EWAX2	\$7,725.05
60" x .210 x 1	6021EWAX2	\$8,901.72
60" x .250 x 1	6025EWAX2	\$11,680.20

PLEASE CALL FOR ADDITIONAL SIZES



**X1000**  
ASPHALT

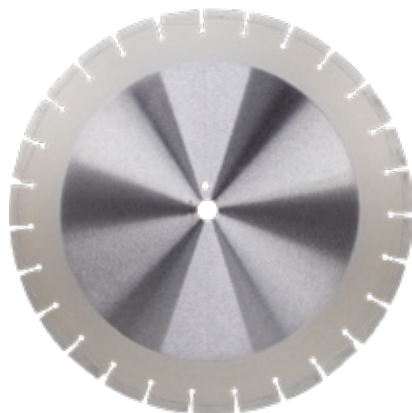

Size	Part #	List Price
12" x .125 x 1	1212EWAX1	\$646.62
12" x .155 x 1	1215EWAX1	\$732.24
12" x .187 x 1	1218EWAX1	\$823.57
12" x .250 x 1	1225EWAX1	\$1,030.66
12" x .375 x 1	1237EWAX1	\$1,144.19
12" x .500 x 1	1250EWAX1	\$1,897.45
14" x .125 x 1	1412EWAX1	\$744.96
14" x .140 x 1	1414EWAX1	\$801.50
14" x .155 x 1	1415EWAX1	\$864.57
14" x .165 x 1	1416EWAX1	\$944.81
14" x .187 x 1	1418EWAX1	\$960.58

◆◆◆ STANDARD GRADE

- 10mm (.394") segment height
- Most economical version of our professional series asphalt blades (not for machines over 65HP)

APPLICATIONS - Asphalt

Size	Part #	List Price
14" x .250 x 1	1425EWAX1	\$1,179.24
14" x .310 x 1	1431EWAX1	\$1,353.97
14" x .375 x 1	1437EWAX1	\$1,423.24
14" x .500 x 1	1450EWAX1	\$2,049.99
16" x .125 x 1	1612EWAX1	\$870.29
16" x .140 x 1	1614EWAX1	\$939.33
16" x .155 x 1	1615EWAX1	\$1,003.68
16" x .187 x 1	1618EWAX1	\$1,129.71
16" x .250 x 1	1625EWAX1	\$1,345.80
16" x .375 x 1	1637EWAX1	\$1,669.80
18" x .125 x 1	1812EWAX1	\$1,019.33
18" x .140 x 1	1814EWAX1	\$1,103.89
18" x .155 x 1	1815EWAX1	\$1,176.31
18" x .165 x 1	1816EWAX1	\$1,234.36
18" x .187 x 1	1818EWAX1	\$1,330.84
18" x .210 x 1	1821EWAX1	\$1,453.02
18" x .250 x 1	1825EWAX1	\$1,592.12
18" x .375 x 1	1837EWAX1	\$1,899.67
20" x .125 x 1	2012EWAX1	\$1,157.51
20" x .140 x 1	2014EWAX1	\$1,253.17
20" x .155 x 1	2015EWAX1	\$1,364.01
20" x .165 x 1	2016EWAX1	\$1,409.34
20" x .187 x 1	2018EWAX1	\$1,541.32
20" x .375 x 1	2037EWAX1	\$2,411.26
24" x .125 x 1	2412EWAX1	\$1,460.49
24" x .140 x 1	2414EWAX1	\$1,562.57
24" x .155 x 1	2415EWAX1	\$1,718.04
24" x .165 x 1	2416EWAX1	\$1,750.62

Size	Part #	List Price
24" x .187 x 1	2418EWAX1	\$1,907.97
24" x .210 x 1	2421EWAX1	\$2,098.35
24" x .250 x 1	2425EWAX1	\$2,178.24
26" x .155 x 1	2615EWAX1	\$2,185.72
26" x .165 x 1	2616EWAX1	\$2,220.64
26" x .187 x 1	2618EWAX1	\$2,383.00
30" x .155 x 1	3015EWAX1	\$2,644.99
30" x .165 x 1	3016EWAX1	\$2,684.46
30" x .175 x 1	3017EWAX1	\$2,828.13
30" x .187 x 1	3018EWAX1	\$2,867.60
30" x .210 x 1	3021EWAX1	\$3,096.77
30" x .250 x 1	3025EWAX1	\$3,214.74
36" x .175 x 1	3617EWAX1	\$3,603.69
36" x .187 x 1	3618EWAX1	\$3,652.51
36" x .210 x 1	3621EWAX1	\$4,013.43
36" x .250 x 1	3625EWAX1	\$4,116.92
42" x .187 x 1	4218EWAX1	\$4,794.26
42" x .210 x 1	4221EWAX1	\$5,207.03
42" x .250 x 1	4225EWAX1	\$5,260.52
48" x .187 x 1	4818EWAX1	\$5,392.40
48" x .210 x 1	4821EWAX1	\$5,962.39
48" x .250 x 1	4825EWAX1	\$6,120.31
54" x .187 x 1	5418EWAX1	\$6,976.01
54" x .210 x 1	5421EWAX1	\$7,655.32
60" x .210 x 1	6021EWAX1	\$8,825.09
60" x .250 x 1	6025EWAX1	\$11,394.15





## ZENESIS™ V SERIES

WALL SAW

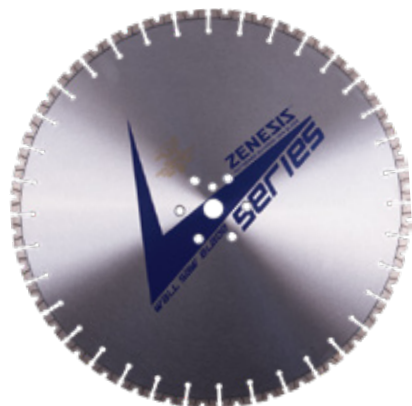

## ZENESIS™ GRADE

- Features ZENESIS™, the most advanced diamond pattern for fast cutting through hard, reinforced concrete and long blade life
- All-New 12mm segments
- Laser welded

**APPLICATIONS** - Hard Reinforced Concrete

Size	Part #	List Price
20" x .125 x 1	2012EWWWZ4	\$1,484.13
20" x .140 x 1	2014EWWWZ4	\$1,480.54
20" x .155 x 1	2015EWWWZ4	\$1,552.03
20" x .165 x 1	2016EWWWZ4	\$1,588.11
20" x .187 x 1	2018EWWWZ4	\$1,685.31
24" x .125 x 1	2412EWWWZ4	\$1,782.84
24" x .140 x 1	2414EWWWZ4	\$1,873.40
24" x .155 x 1	2415EWWWZ4	\$1,943.87
24" x .165 x 1	2416EWWWZ4	\$1,967.35
24" x .187 x 1	2418EWWWZ4	\$2,118.50
24" x .210 x 1	2421EWWWZ4	\$2,244.97
24" x .250 x 1	2425EWWWZ4	\$2,424.89
26" x .155 x 1	2615EWWWZ4	\$2,446.67
26" x .165 x 1	2616EWWWZ4	\$2,461.48
26" x .187 x 1	2618EWWWZ4	\$2,614.51
30" x .155 x 1	3015EWWWZ4	\$3,005.84
30" x .165 x 1	3016EWWWZ4	\$3,034.10
30" x .175 x 1	3017EWWWZ4	\$3,163.96
30" x .187 x 1	3018EWWWZ4	\$3,206.52

Size	Part #	List Price
30" x .210 x 1	3021EWWWZ4	\$3,356.99
30" x .250 x 1	3025EWWWZ4	\$3,606.02
32" x .235 x 1	3223EWWWZ4	\$3,541.14
32" x .250 x 1	3225EWWWZ4	\$3,789.23
36" x .175 x 1	3617EWWWZ4	\$4,121.26
36" x .187 x 1	3618EWWWZ4	\$4,319.39
36" x .210 x 1	3621EWWWZ4	\$4,539.48
36" x .250 x 1	3625EWWWZ4	\$4,671.91
42" x .187 x 1	4218EWWWZ4	\$6,090.83
42" x .210 x 1	4221EWWWZ4	\$6,334.58
42" x .250 x 1	4225EWWWZ4	\$6,691.86
48" x .187 x 1	4818EWWWZ4	\$6,703.61
48" x .210 x 1	4821EWWWZ4	\$7,128.46
48" x .250 x 1	4825EWWWZ4	\$7,578.17
54" x .187 x 1	5418EWWWZ4	\$8,935.65
54" x .210 x 1	5421EWWWZ4	\$9,599.65
60" x .210 x 1	6021EWWWZ4	\$11,197.47
60" x .250 x 1	6025EWWWZ4	\$11,487.85

## X1000

WALL SAW



## ◆◆◆ STANDARD PLUS GRADE

- 10mm (.394") segment height
- Our most economical wall saw blade
- For air or hydraulic saws
- Available in 3 bonds

**APPLICATIONS** - Hard Concrete, Critically Hard Concrete

### HARD CONCRETE

Size	Part #	List Price
16" x .187" x 1"	1618EWWW1-1V	\$1,054.28
16" x .187" x 1"	1618EWWW1-1VM*	\$1,054.28
16" x .220" x 1"	1622EWWW1-1V	\$1,138.74
16" x .235" x 1"	1623EWWW1-1VM*	\$1,193.22
16" x .250" x 1"	1625EWWW1-1V	\$1,182.32
20" x .125" x 1"	2012EWWW1-1V	\$1,160.53
20" x .140" x 1"	2014EWWW1-1V	\$1,236.81
20" x .140" x 1"	2014EWWW1-1VM*	\$1,236.81
20" x .155" x 1"	2015EWWW1-1V	\$1,321.26
20" x .235" x 1"	2023EWWW1-1V	\$1,675.41
20" x .250" x 1"	2025EWWW1-1V	\$1,708.10
24" x .140" x 1"	2414EWWW1-1V	\$1,544.64
24" x .140" x 1"	2414EWWW1-1VM*	\$1,544.64
24" x .165" x 1"	2416EWWW1-1V	\$1,618.20
24" x .187" x 1"	2418EWWW1-1V	\$1,751.69
24" x .235" x 1"	2423EWWW1-1V	\$1,923.32
24" x .250" x 1"	2425EWWW1-1V	\$2,067.70
26" x .187" x 1"	2618EWWW1-1V	\$2,056.80
26" x .235" x 1"	2623EWWW1-1V	\$2,285.64
30" x .140" x 1"	3014EWWW1-1V	\$2,225.71
30" x .155" x 1"	3015EWWW1-1V	\$2,081.32
30" x .187" x 1"	3018EWWW1-1V	\$2,503.58
30" x .235" x 1"	3023EWWW1-1V	\$2,884.98
30" x .250" x 1"	3025EWWW1-1V	\$2,898.60
32" x .250" x 1"	3225EWWW1-1V	\$3,296.34

### CRITICALLY HARD CONCRETE

Size	Part #	List Price
14" x .125 x 1	1412EWWW1-05V	\$702.86
14" x .125 x 1	1412EWWW1-05VM*	\$702.86
14" x .140 x 1	1414EWWW1-05V	\$700.13
14" x .187 x 1	1418EWWW1-05V	\$839.07
16" x .125 x 1	1612EWWW1-05V	\$806.38
16" x .125 x 1	1612EWWW1-05VM*	\$806.38
16" x .187 x 1	1618EWWW1-05VM*	\$1,054.28
20" x .125 x 1	2012EWWW1-05V	\$1,160.53
20" x .140 x 1	2014EWWW1-05V	\$1,236.81
24" x .125 x 1	2412EWWW1-05V	\$1,381.19
24" x .235 x 1	2423EWWW1-05V	\$1,923.32
30" x .235 x 1	3023EWWW1-05V	\$2,884.98

### HARD CONCRETE

Size	Part #	List Price
12" x .250 x 1"	1225EWWW1-1V	\$836.35
14" x .125 x 1"	1412EWWW1-1VM*	\$702.86
14" x .165" x 1"	1416EWWW1-1V	\$830.90
16" x .125" x 1"	1612EWWW1-1V	\$806.38
16" x .125" x 1"	1612EWWW1-1VM*	\$806.38
16" x .140" x 1"	1614EWWW1-1V	\$817.28
16" x .140" x 1"	1614EWWW1-1VM*	\$817.28
16" x .165" x 1"	1616EWWW1-1V	\$983.45
16" x .165" x 1"	1616EWWW1-1VM*	\$983.45

**ZENESIS™**  
CONCRETE



**ZENESIS™ GRADE**

- 10mm (.394") segment height
- Exclusive "patterned" technology for maximum performance
- Offers 10" depth of cut
- Includes free drive wheel
- Available in various sizes and bonds based on application

**APPLICATIONS** - Cured Concrete, Masonry, Roofing Tile

Size	Part #	List Price
14 x .165 x DRIVE (1 bond)	<b>1416RZX4-1</b>	\$674.30
14 x .165 x DRIVE (2 bond)	<b>1416RZX4</b>	\$674.30
14 x .235 x DRIVE (2 bond)	1423RZX4	\$809.20
14 x .165 x DRIVE (3 bond)	1416RZX4-3	\$674.30

**X200**  
CONCRETE



**HEAVY DUTY GRADE**

- 8mm (.315") segment height
- Heavy Duty blade
- Offers 10" depth of cut
- Includes free drive wheel
- Available in various sizes and bonds based on application

**APPLICATIONS** - Cured Concrete, Masonry, Roofing Tile

Size	Part #	List Price
14 x .165 x Drive (1 bond)	<b>1416RDUX2-1</b>	\$468.84
14 x .165 x Drive (2 bond)	<b>1416RDUX2-2</b>	\$468.84
14 x .235 x Drive (2 bond)	<b>1423RDUX2-2</b>	\$518.71
14 x .165 x Drive (3 bond)	1416RDUX2-3	\$497.93

**DRIVE WHEEL**  
FOR RING SAWS



- Free with purchase of any ring saw blade (also sold separately)

Size	Part #	List Price
DRIVE WHEEL	<b>DW</b>	\$47.65

## PAVEMENT GRINDING

PAVEMENT

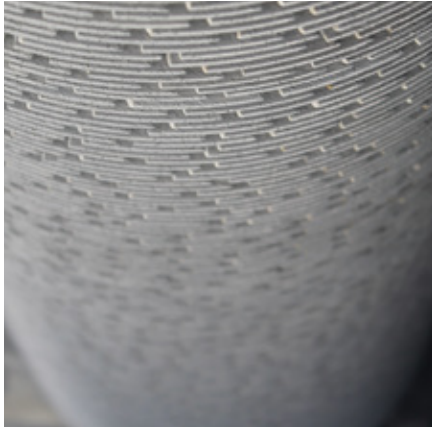

- Diamond Vantage® offers blades for removing layers of concrete or asphalt. These blades are stacked together with spacers between the blades. This offers incredibly efficient removal of any unwanted pavement
- Grinding can solve many irregularities in the pavement, including:
  - Faulting at joints or cracks
  - Roughness
  - Wheel ruts in older concrete
  - High noise levels
  - Warping caused by moisture
- Our grinding blades are available with ZENESIS™ Technology 2.0, the world's most advanced pattern technology, which ensures smooth consistent grinds and long blade life

**APPLICATIONS** - Pavement, Concrete, Asphalt

CALL FOR PRICING



## PREMIUM DIAMOND WIRE

HARD CONCRETE



### PREMIUM GRADE

- Available for wet and dry sawing
- 10.5 & 11mm bead sizes

**APPLICATIONS** - Hard Concrete

Beads Per Meter	Bead Size	Application	Part #	List Price (Per Meter)
40	10.5mm	Critically Hard Concrete / Regular Type	40105WSCX2-1	\$670.33
40	10.5mm	Concrete / Regular Type	40105WSCX2	\$600.71
40	10.5mm	Concrete / Electroplated Type	40105WSCXEW	\$467.21
48	10.5mm	Concrete, w/heavy steel / Brazed Single Layer (BSL) Type	48105WSCBSLR	\$724.65
48	11mm	Concrete, w/heavy steel / Brazed Single Layer (BSL) Type	48110WSCBSL	\$591.13
36	11mm	Granite (class 3-4) / Regular Type	36110WSGX2	\$419.56

## ECONOMY DIAMOND WIRE

CONCRETE



### ECONOMY GRADE

- Available for wet sawing only
- 10.5mm bead size

**APPLICATIONS** - Concrete

Beads Per Meter	Bead Size	Application	Part #	List Price (Per Meter)
40	10.5mm	Concrete / Regular Type	40105WSCSI	\$315.99



# CORE DRILLING

## CORE BIT PERFORMANCE CHART

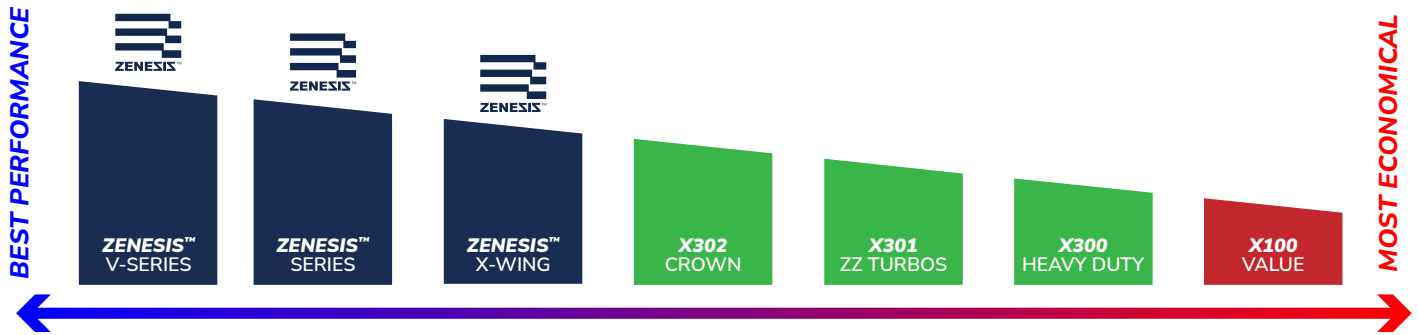

### ZENESIS™ V SERIES HARD CONCRETE



### ZENESIS™ GRADE

- 12mm (.472") segment height optimized with high grade diamond and concentration to core through hard applications and heavily reinforced concrete
- ZENESIS™ Pattern Diamond Technology for maximum performance and consistency from bit to bit
- Fast drilling of cured concrete with heavy rebar
- V-notched segment design helps increase speed and initial hole coring
- Made in the USA to withstand the toughest drilling applications
- Laser welded patterned diamond array for consistent speed and life in rugged applications
- 14" barrel length

**APPLICATIONS** - Hard Concrete, Brick, Reinforced Concrete, Concrete Block

Size	Part #	List Price
2 x .155 x 1¼-7	<b>02015JWHZX4-1</b>	\$267.53
2½ x .155 x 1¼-7	02515JWHZX4-1	\$314.74
3 x .155 x 1¼-7	<b>03015JWHZX4-1</b>	\$361.95
3½ x .155 x 1¼-7	03515JWHZX4-1	\$409.17
4 x .155 x 1¼-7	<b>04015JWHZX4-1</b>	\$440.64
4¼ x .155 x 1¼-7	04215JWHZX4-1	\$474.79
4½ x .155 x 1¼-7	04515JWHZX4-1	\$516.17
5 x .155 x 1¼-7	05015JWHZX4-1	\$558.67

Size	Part #	List Price
6 x .155 x 1¼-7	06015JWHZX4-1	\$629.48
6½ x .155 x 1¼-7	06515JWHZX4-1	\$679.47
7 x .165 x 1¼-7	07016JWHZX4-1	\$763.25
8 x .165 x 1¼-7	08016JWHZX4-1	\$1,113.08
10 x .187 x 1¼-7	10018JWHZX4-1	\$1,425.60
12 x .187 x 1¼-7	12018JWHZX4-1	\$1,878.71
14 x .187 x 1¼-7	14018JWHZX4-1	\$2,430.00

PART #'S IN BOLD INDICATE ROUTINELY STOCKED PRODUCTS

**ZENESIS™ SERIES**  
HARD CONCRETE



**ZENESIS™ GRADE**

- 10mm (.394") segment height
- ZENESIS™ Pattern Diamond Technology for maximum performance and consistency from bit to bit
- 14" long barrel

**APPLICATIONS** - Hard Concrete, Granite, Brick, Reinforced Concrete, Concrete Block

Size	Part #	List Price
2 x .155 x 1 1/4-7	<b>02015JWHZX4-1</b>	\$267.53
2 1/2 x .155 x 1 1/4-7	02515JWHZX4-1	\$314.74
3 x .155 x 1 1/4-7	<b>03015JWHZX4-1</b>	\$361.95
3 1/2 x .155 x 1 1/4-7	03515JWHZX4-1	\$409.17
4 x .155 x 1 1/4-7	<b>04015JWHZX4-1</b>	\$440.64
4 1/4 x .155 x 1 1/4-7	04215JWHZX4-1	\$474.79
4 1/2 x .155 x 1 1/4-7	04515JWHZX4-1	\$516.17
5 x .155 x 1 1/4-7	05015JWHZX4-1	\$558.67

Size	Part #	List Price
6 x .155 x 1 1/4-7	06015JWHZX4-1	\$629.48
6 1/2 x .155 x 1 1/4-7	06515JWHZX4-1	\$679.47
7 x .165 x 1 1/4-7	07016JWHZX4-1	\$763.25
8 x .165 x 1 1/4-7	08016JWHZX4-1	\$1,113.08
10 x .187 x 1 1/4-7	10018JWHZX4-1	\$1,425.60
12 x .187 x 1 1/4-7	12018JWHZX4-1	\$1,878.71
14 x .187 x 1 1/4-7	14018JWHZX4-1	\$2,430.00

**NEW**  
**ZENESIS™ X-WING**  
CONCRETE & MASONRY



**ZENESIS™ GRADE**

- 10mm (.394") segment height
- ZENESIS™ X-Wing Core Bit features a new unique segment design, to create fast drilling speed and precise cutting wet or dry to get the job done effectively and efficiently
- Unique X-Wing Turbo segment design
- ZENESIS™ Pattern Diamond Technology for maximum performance and consistency from bit to bit

**APPLICATIONS** - Masonry, Brick, Concrete, Concrete Block

Size	Part #	List Price
2 x .134 x 1 1/4-7	02013JXDHZX4-2	\$214.29
2 1/2 x .134 x 1 1/4-7	02513JXDHZX4-2	\$296.57
3 x .134 x 1 1/4-7	03013JXDHZX4-2	\$316.29
3 1/2 x .134 x 1 1/4-7	03513JXDHZX4-2	\$395.14
4 x .134 x 1 1/4-7	04013JXDHZX4-2	\$402.00

Size	Part #	List Price
4 1/4 x .134 x 1 1/4-7	04213JXDHZX4-2	\$412.29
4 1/2 x .134 x 1 1/4-7	04513JXDHZX4-2	\$500.57
5 x .134 x 1 1/4-7	05013JXDHZX4-2	\$508.29
6 x .134 x 1 1/4-7	06013JXDHZX4-2	\$605.14
6 1/2 x .134 x 1 1/4-7	06513JXDHZX4-2	\$701.14

**NEW**  
**GEARED TURBO**  
HARD CONCRETE



**PREMIUM GRADE**

- 11mm (.433") segment height
- Unique gear shaped turbo segment
- This premium core bit is designed for speed, making it the fastest core bit in our lineup

**APPLICATIONS** - Hard Concrete, Granite, Brick, Reinforced Concrete, Concrete Block

Size	Part #	List Price
2 X 1 1/4-7	02014JWZH2-05	\$177.97
2 1/4 X 1 1/4-7	02214JWZH2-05	\$186.12
2 1/2 X 1 1/4-7	02514JWZH2-05	\$209.81
2 3/4 X 1 1/4-7	02714JWZH2-05	\$227.76
3 X 1 1/4-7	03014JWZH2-05	\$250.63
3 1/4 X 1 1/4-7	03214JWZH2-05	\$252.24
3 1/2 X 1 1/4-7	03514JWZH2-05	\$279.17
4 X 1 1/4-7	04014JWZH2-05	\$308.58
4 1/4 X 1 1/4-7	04214JWZH2-05	\$326.53
4 1/2 X 1 1/4-7	04514JWZH2-05	\$355.12
5 X 1 1/4-7	05014JWZH2-05	\$384.49

Size	Part #	List Price
5 1/2 X 1 1/4-7	05514JWZH2-05	\$413.06
6 X 1 1/4-7	06014JWZH2-05	\$461.25
6 1/4 X 1 1/4-7	06214JWZH2-05	\$516.72
6 1/2 X 1 1/4-7	06514JWZH2-05	\$544.49
7 X 1 1/4-7	07016JWZH2-05	\$609.81
8 X 1 1/4-7	08016JWZH2-05	\$694.69
9 X 1 1/4-7	09018JWZH2-05	\$864.49
10 X 1 1/4-7	10018JWZH2-05	\$956.73
11 X 1 1/4-7	11018JWZH2-05	\$1,029.39
12 X 1 1/4-7	12018JWZH2-05	\$1,172.26
14 X 1 1/4-7	14018JWZH2-05	\$1,386.13

**X301 ZZ TURBO**  
HARD CONCRETE



**PREMIUM GRADE**

- 9.5mm (.374") segment height
- 14" barrel length

**APPLICATIONS** - Hard Concrete, Granite, Brick, Reinforced Concrete, Concrete Block

Size	Part #	List Price
1 x .125 x 5/8-11	<b>01012HWZGH-1</b>	\$133.86
1 x .125 x 1 1/4-7	<b>01012JWZGH-1</b>	\$133.86
1 1/8 x .125 x 5/8-11	<b>01112HWZGH-1</b>	\$144.39
1 1/4 x .125 x 5/8-11	<b>01212HWZGH-1</b>	\$153.58
1 1/4 x .125 x 1 1/4-7	<b>01212JWZGH-1</b>	\$153.58
1 1/2 x .125 x 5/8-11	<b>01512HWZGH-1</b>	\$163.99
1 1/2 x .125 x 1 1/4-7	<b>01512JWZGH-1</b>	\$163.99
1 3/4 x .125 x 1 1/4-7	<b>01712JWZGH-1</b>	\$195.47
2 x .155 x 1 1/4-7	<b>02014JWZGH-1</b>	\$241.39
2 1/4 x .155 x 1 1/4-7	02214JWZGH-1	\$251.93
2 1/2 x .155 x 1 1/4-7	<b>02514JWZGH-1</b>	\$262.45
2 3/4 x .155 x 1 1/4-7	<b>02714JWZGH-1</b>	\$300.54
3 x .155 x 1 1/4-7	<b>03014JWZGH-1</b>	\$338.51
3 1/4 x .155 x 1 1/4-7	03214JWZGH-1	\$366.07
3 1/2 x .155 x 1 1/4-7	<b>03514JWZGH-1</b>	\$393.62

Size	Part #	List Price
4 x .155 x 1 1/4-7	<b>04014JWZGH-1</b>	\$419.95
4 1/4 x .155 x 1 1/4-7	04214JWZGH-1	\$433.06
4 1/2 x .155 x 1 1/4-7	<b>04514JWZGH-1</b>	\$472.38
5 x .155 x 1 1/4-7	<b>05014JWZGH-1</b>	\$524.92
5 1/2 x .155 x 1 1/4-7	<b>05514JWZGH-1</b>	\$577.33
6 x .155 x 1 1/4-7	<b>06014JWZGH-1</b>	\$629.87
6 1/4 x .155 x 1 1/4-7	06214JWZGH-1	\$642.98
6 1/2 x .155 x 1 1/4-7	06514JWZGH-1	\$695.52
7 x .165 x 1 1/4-7	<b>07016JWZGH-1</b>	\$747.94
8 x .165 x 1 1/4-7	<b>08016JWZGH-1</b>	\$839.80
9 x .187 x 1 1/4-7	<b>09018JWZGH-1</b>	\$944.75
10 x .187 x 1 1/4-7	<b>10018JWZGH-1</b>	\$1,062.93
11 x .187 x 1 1/4-7	<b>11018JWZGH-1</b>	\$1,233.42
12 x .187 x 1 1/4-7	<b>12018JWZGH-1</b>	\$1,325.27
14 x .187 x 1 1/4-7	<b>14018JWZGH-1</b>	\$1,600.83

**X300**  
HARD CONCRETE



**PREMIUM GRADE**

- 8mm (.315") segment height
- 14" barrel length

**APPLICATIONS** - Hard Concrete, Granite, Brick, Reinforced Concrete, Concrete Block

Size	Part #	List Price
3/4 x .125 x 5/8-11	00712HWHX2-1	\$125.41
3/4 x .125 x 1 1/4-7	00712JWHX2-1	\$125.41
1 x .125 x 5/8-11	01012HWHX2-1	\$136.92
1 x .125 x 1 1/4-7	01012JWHX2-1	\$136.92
1 1/8 x .125 x 5/8-11	01112HWHX2-1	\$142.07
1 1/8 x .125 x 1 1/4-7	01112JWHX2-1	\$142.07
1 1/4 x .125 x 5/8-11	01212HWHX2-1	\$159.58
1 1/4 x .125 x 1 1/4-7	01212JWHX2-1	\$159.58
1 1/2 x .125 x 5/8-11	01512HWHX2-1	\$171.21
1 1/2 x .125 x 1 1/4-7	01512JWHX2-1	\$171.21
1 3/4 x .125 x 5/8-11	01712HWHX2-1	\$188.97
1 3/4 x .125 x 1 1/4-7	01712JWHX2-1	\$188.97
2 x .125 x 1 1/4-7	02014JWHX2-1	\$233.43
2 1/4 x .125 x 5/8-11	02214JWHX2-1	\$243.59
2 1/2 x .155 x 1 1/4-7	02514JWHX2-1	\$253.64
2 3/4 x .155 x 1 1/4-7	02714JWHX2-1	\$290.51

Size	Part #	List Price
3 x .155 x 1 1/4-7	<b>03014JWHX2-1</b>	\$327.25
3 1/4 x .155 x 1 1/4-7	03214JWHX2-1	\$342.43
3 1/2 x .155 x 1 1/4-7	03514JWHX2-1	\$380.53
4 x .155 x 1 1/4-7	<b>04014JWHX2-1</b>	\$405.87
4 1/4 x .155 x 1 1/4-7	04214JWHX2-1	\$418.60
4 1/2 x .155 x 1 1/4-7	04514JWHX2-1	\$456.70
5 x .155 x 1 1/4-7	<b>05014JWHX2-1</b>	\$507.40
5 1/2 x .155 x 1 1/4-7	05514JWHX2-1	\$558.11
6 x .155 x 1 1/4-7	<b>06014JWHX2-1</b>	\$608.81
6 1/4 x .155 x 1 1/4-7	06214JWHX2-1	\$621.55
6 1/2 x .155 x 1 1/4-7	06514JWHX2-1	\$684.98
7 x .155 x 1 1/4-7	<b>07016JWHX2-1</b>	\$723.07
8 x .165 x 1 1/4-7	08016JWHX2-1	\$811.86
9 x .187 x 1 1/4-7	09018JWHX2-1	\$913.28
10 x .187 x 1 1/4-7	10018JWHX2-1	\$1,027.42
11 x .187 x 1 1/4-7	11018JWHX2-1	\$1,192.39

**X301 ZZ TURBO**  
CONCRETE

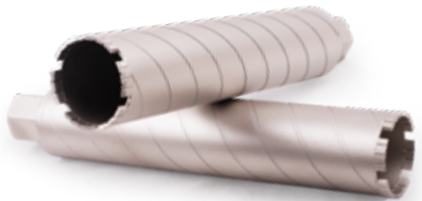

**PREMIUM GRADE**

- 9.5mm (.374") segment height
- Unique slanted turbo segment design, with spiral barrel for fast drilling
- Combination of speed and life
- Select sizes available in 1 1/4"-7 and 5/8"-11 threading
- 14" barrel length

**APPLICATIONS** - Hard Concrete, Cured Concrete, Reinforced Concrete, Concrete Block, Brick

Size	Part #	List Price
1 x .125 x 5/8-11	<b>01012HWZGH</b>	\$133.86
1 x .125 x 1 1/4-7	<b>01012JWZGH</b>	\$133.86
1 1/8 x .125 x 5/8-11	<b>01112HWZGH</b>	\$144.39
1 1/4 x .125 x 5/8-11	<b>01212HWZGH</b>	\$153.58
1 1/4 x .125 x 1 1/4-7	<b>01212JWZGH</b>	\$153.58

Size	Part #	List Price
1 1/2 x .125 x 1 1/4-11	<b>01512HWZGH</b>	\$163.99
1 1/2 x .125 x 1 1/4-7	<b>01512JWZGH</b>	\$163.99
1 3/4 x .125 x 1 1/4-7	<b>01712JWZGH</b>	\$195.47
2 x .155 x 1 1/4-7	<b>02014JWZGH</b>	\$241.39
2 1/4 x .155 x 1 1/4-7	02214JWZGH	\$251.93
2 1/2 x .155 x 1 1/4-7	<b>02514JWZGH</b>	\$262.45
2 3/4 x .155 x 1 1/4-7	<b>02714JWZGH</b>	\$300.54
3 x .155 x 1 1/4-7	<b>03014JWZGH</b>	\$338.51
3 1/4 x .155 x 1 1/4-7	03214JWZGH	\$366.07
3 1/2 x .155 x 1 1/4-7	<b>03514JWZGH</b>	\$393.62
4 x .155 x 1 1/4-7	<b>04014JWZGH</b>	\$419.95
4 1/4 x .155 x 1 1/4-7	04214JWZGH	\$433.06
4 1/2 x .155 x 1 1/4-7	<b>04514JWZGH</b>	\$472.38

Size	Part #	List Price
5 x .155 x 1 1/4-7	<b>05014JWZGH</b>	\$524.92
5 1/2 x .155 x 1 1/4-7	<b>05514JWZGH</b>	\$577.33
6 x .155 x 1 1/4-7	<b>06014JWZGH</b>	\$629.87
6 1/4 x .155 x 1 1/4-7	06214JWZGH	\$642.98
6 1/2 x .155 x 1 1/4-7	06514JWZGH	\$695.52
7 x .165 x 1 1/4-7	<b>07016JWZGH</b>	\$747.94
8 x .165 x 1 1/4-7	<b>08016JWZGH</b>	\$839.80
9 x .187 x 1 1/4-7	<b>09018JWZGH</b>	\$944.75
10 x .187 x 1 1/4-7	<b>10018JWZGH</b>	\$1,062.93
11 x .187 x 1 1/4-7	<b>11018JWZGH</b>	\$1,233.42
12 x .187 x 1 1/4-7	<b>12018JWZGH</b>	\$1,325.27
14 x .187 x 1 1/4-7	<b>14018JWZGH</b>	\$1,600.83
14 x .187 x 1 1/4-7	14018JWZGH	\$1,600.83



**X300**  
CONCRETE



Size	Part #	List Price
3/4 x .125 x 3/8-11	<b>00712HWHX2</b>	\$125.41
3/4 x .125 x 1 1/4-7	00712JWHX2	\$125.41
7/8 x .125 x 1 1/4-7	<b>00812JWHX2</b>	\$129.21
1 x .125 x 3/8-11	<b>01012HWHX2</b>	\$136.92
1 x .125 x 1 1/4-7	<b>01012JWHX2</b>	\$136.92

**PREMIUM GRADE**

- 8mm (.315") segment height
- Select sizes available in 1 1/4"-7 and 3/8"-11 threading
- 14" barrel length

**APPLICATIONS** - Hard Concrete, Cured Concrete, Reinforced Concrete, Concrete Block, Brick

Size	Part #	List Price
1 1/8 x .125 x 3/8-11	<b>01112HWHX2</b>	\$142.07
1 1/8 x .125 x 1 1/4-7	01112JWHX2	\$142.07
1 1/4 x .125 x 3/8-11	<b>01212HWHX2</b>	\$159.58
1 1/4 x .125 x 1 1/4-7	01212JWHX2	\$159.58
1 1/2 x .125 x 3/8-11	<b>01512HWHX2</b>	\$171.21
1 1/2 x .125 x 1 1/4-7	<b>01512JWHX2</b>	\$171.21
1 3/4 x .125 x 3/8-11	01712HWHX2	\$188.97
1 3/4 x .125 x 1 1/4-7	<b>01712JWHX2</b>	\$188.97
2 x .155 x 1 1/4-7	<b>02014JWHX2</b>	\$233.43
2 1/4 x .155 x 1 1/4-7	02214JWHX2	\$243.59
2 1/2 x .155 x 1 1/4-7	<b>02514JWHX2</b>	\$253.64
2 3/4 x .155 x 1 1/4-7	02714JWHX2	\$290.51
3 x .155 x 1 1/4-7	<b>03014JWHX2</b>	\$327.25
3 1/4 x .155 x 1 1/4-7	03214JWHX2	\$342.43
3 1/2 x .155 x 1 1/4-7	<b>03514JWHX2</b>	\$380.53

Size	Part #	List Price
4 x .155 x 1 1/4-7	<b>04014JWHX2</b>	\$405.87
4 1/4 x .155 x 1 1/4-7	<b>04214JWHX2</b>	\$418.60
4 1/2 x .155 x 1 1/4-7	<b>04514JWHX2</b>	\$456.70
5 x .155 x 1 1/4-7	<b>05014JWHX2</b>	\$507.40
5 1/2 x .155 x 1 1/4-7	<b>05514JWHX2</b>	\$558.11
6 x .155 x 1 1/4-7	<b>06014JWHX2</b>	\$608.81
6 1/4 x .155 x 1 1/4-7	<b>06214JWHX2</b>	\$621.55
6 1/2 x .155 x 1 1/4-7	06514JWHX2	\$684.98
7 x .165 x 1 1/4-7	<b>07016JWHX2</b>	\$723.07
8 x .165 x 1 1/4-7	<b>08016JWHX2</b>	\$811.86
9 x .187 x 1 1/4-7	<b>09018JWHX2</b>	\$913.28
10 x .187 x 1 1/4-7	<b>10018JWHX2</b>	\$1,027.42
11 x .187 x 1 1/4-7	11018JWHX2	\$1,192.39
12 x .187 x 1 1/4-7	<b>12018JWHX2</b>	\$1,281.18
14 x .187 x 1 1/4-7	<b>14018JWHX2</b>	\$1,547.56

**X302 CROWN**  
GENERAL PURPOSE



**PREMIUM GRADE**

- 8mm (.315") segment height
- Crown style eliminates segment loss in heavy rebar and wire mesh
- 14" barrel length

**APPLICATIONS** - Masonry, Brick, Concrete Block

Size	Part #	List Price
1/2 x .125 x 3/8-11	<b>00512HWKH</b>	\$137.17
5/8 x .125 x 3/8-11	<b>00612HWKH</b>	\$140.23
3/4 x .125 x 3/8-11	<b>00712HWKH</b>	\$141.58
7/8 x .125 x 3/8-11	<b>00812HWKH</b>	\$143.29
7/8 x .125 x 1 1/4-7	00812JWKH	\$142.37
1 x .125 x 3/8-11	<b>01012HWKH</b>	\$145.08
1 1/8 x .125 x 3/8-11	<b>01112HWKH</b>	\$155.94
1 1/4 x .125 x 3/8-11	<b>01212HWKH</b>	\$165.43
1 1/4 x .125 x 1 1/4-7	01212JWKH	\$166.65

Size	Part #	List Price
13/8 x .125 x 3/8-11	<b>01312HWKH</b>	\$176.27
1 1/2 x .125 x 3/8-11	<b>01512HWKH</b>	\$189.83
1 5/8 x .125 x 3/8-11	01612HWKH	\$203.39
1 3/4 x .125 x 3/8-11	01712HWKH	\$216.95
1 3/4 x .125 x 1 1/4-7	01712JWKH	\$216.95
1 7/8 x .125 x 3/8-11	01812HWKH	\$237.29
2 x .125 x 3/8-11	02012HWKH	\$263.05
2 1/4 x .125 x 3/8-11	02212HWKH	\$277.97
2 1/2 x .125 x 3/8-11	02512HWKH	\$291.53

**X301 ZZ TURBO**  
PRE-STRESSED CONCRETE



**PREMIUM GRADE**

- 9.5mm (.374") segment height
- For use on pre-stressed concrete
- Close spaced segments for heavy rebar
- 14" barrel length
- Less space between segments eliminates segment loss

**APPLICATIONS** - Pre-stressed Concrete, Concrete with loose rebar

Size	Part #	List Price
1 x .145 x 3/8-11	P01014HWZGH	\$192.16
1 1/2 x .165 x 3/8-11	<b>P01516HWZGH</b>	\$237.96
2 x .165 x 1 1/4-7	<b>P02016JWZGH</b>	\$280.95
2 1/2 x .165 x 1 1/4-7	<b>P02516JWZGH</b>	\$305.08
3 x .165 x 1 1/4-7	<b>P03016JWZGH</b>	\$367.54
3 1/2 x .165 x 1 1/4-7	<b>P03516JWZGH</b>	\$402.57
4 x .165 x 1 1/4-7	<b>P04016JWZGH</b>	\$504.83

Size	Part #	List Price
4 1/2 x .165 x 1 1/4-7	P04516JWZGH	\$566.56
5 x .165 x 1 1/4-7	<b>P05016JWZGH</b>	\$627.67
5 1/2 x .165 x 1 1/4-7	P05516JWZGH	\$677.88
6 x .165 x 1 1/4-7	<b>P06016JWZGH</b>	\$722.22
8 x .165 x 1 1/4-7	P08016JWZGH	\$1,059.02
9 x .165 x 1 1/4-7	P09016JWZGH	\$1,189.69
10 x .187 x 1 1/4-7	P10018JWZGH	\$1,499.67

**X300**  
ASPHALT



**PREMIUM GRADE**

- 8mm (.315") segment height
- 14" barrel length

APPLICATIONS - Asphalt, Abrasive Concrete

Size	Part #	List Price
2 x .155 x 1 1/4-7	02014JWHAX2	\$233.43
2 1/4 x .155 x 1 1/4-7	02214JWHAX2	\$243.59
2 1/2 x .155 x 1 1/4-7	02514JWHAX2	\$253.64
3 x .155 x 1 1/4-7	03014JWHAX2	\$327.25
3 1/4 x .155 x 1 1/4-7	03214JWHAX2	\$353.94
3 1/2 x .155 x 1 1/4-7	03514JWHAX2	\$380.53
4 x .155 x 1 1/4-7	<b>04014JWHAX2</b>	\$405.87

Size	Part #	List Price
4 1/4 x .155 x 1 1/4-7	<b>04214JWHAX2</b>	\$418.60
4 1/2 x .155 x 1 1/4-7	04514JWHAX2	\$456.70
5 x .155 x 1 1/4-7	05014JWHAX2	\$507.40
6 x .155 x 1 1/4-7	06014JWHAX2	\$608.81
6 1/4 x .155 x 1 1/4-7	<b>06214JWHAX2</b>	\$621.55
8 x .165 x 1 1/4-7	08016JWHAX2	\$811.86

**X301 ZZ TURBO**  
MASONRY



**PREMIUM GRADE**

- 9mm (.354") segment height
- Not for reinforced concrete
- 10" barrel length
- New barrel design reduces dust released into the air

APPLICATIONS - Masonry, Brick, Concrete Block

Size	Part #	List Price
1 x .110 x 5/8-11	<b>01011H2DZGH</b>	\$127.37
1 1/4 x .110 x 5/8-11	<b>01211H2DZGH</b>	\$137.17
1 1/2 x .110 x 5/8-11	<b>01511H2DZGH</b>	\$145.62
1 3/4 x .110 x 5/8-11	<b>01711H2DZGH</b>	\$182.00
2 x .125 x 5/8-11	<b>02012H2DZGH</b>	\$191.79
2 1/4 x .125 x 5/8-11	<b>02212H2DZGH</b>	\$200.12
2 1/2 x .125 x 5/8-11	<b>02512H2DZGH</b>	\$236.50

Size	Part #	List Price
3 x .125 x 5/8-11	<b>03012H2DZGH</b>	\$272.99
3 1/2 x .125 x 5/8-11	<b>03512H2DZGH</b>	\$363.87
4 x .125 x 5/8-11	<b>04012H2DZGH</b>	\$454.86
4 1/4 x .125 x 5/8-11	04212H2DZGH	\$482.90
4 1/2 x .125 x 5/8-11	<b>04512H2DZGH</b>	\$509.48
5 x .125 x 5/8-11	<b>05012H2DZGH</b>	\$582.23
6 x .125 x 5/8-11	<b>06012H2DZGH</b>	\$655.10

**X300**  
MASONRY

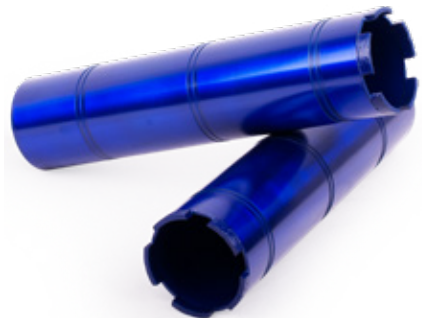

**PREMIUM GRADE**

- 7.5mm (.295") segment height
- Standard style segments for balance of life and speed
- Not for reinforced concrete
- 10" barrel length
- New barrel design reduces dust released into the air

APPLICATIONS - Masonry, Brick, Concrete Block

Size	Part #	List Price
1 x .110 x 5/8-11	<b>01011H2DH</b>	\$119.41
1 1/4 x .110 x 5/8-11	<b>01211H2DH</b>	\$128.60
1 1/2 x .110 x 5/8-11	<b>01511H2DH</b>	\$136.43
1 3/4 x .110 x 5/8-11	01711H2DH	\$170.60
2 x .125 x 5/8-11	<b>02012H2DH</b>	\$179.78
2 1/4 x .125 x 5/8-11	02212H2DH	\$187.63
2 1/2 x .125 x 5/8-11	<b>02512H2DH</b>	\$221.80

Size	Part #	List Price
3 x .125 x 5/8-11	<b>03012H2DH</b>	\$255.84
3 1/2 x .125 x 5/8-11	<b>03512H2DH</b>	\$341.21
4 x .125 x 5/8-11	<b>04012H2DH</b>	\$426.45
4 1/4 x .125 x 5/8-11	04212H2DH	\$452.66
4 1/2 x .125 x 5/8-11	<b>04512H2DH</b>	\$477.64
5 x .125 x 5/8-11	<b>05012H2DH</b>	\$545.86
6 x .125 x 5/8-11	<b>06012H2DH</b>	\$614.07

**CONTINUOUS RIM CORE BIT**  
CONCRETE



**PREMIUM GRADE**

- 5.5mm (.216") segment height
- Sizes over 1" equipped with pilot drill
- Approximate 35mm drilling depth

**APPLICATIONS** - Concrete, Block, Concrete Brick



Size	Part #	List Price
¼ x .080 x 10mm	<b>S-00308SDCRCB</b>	\$88.55
2¼ x .080 x 10mm	<b>S-02208SDCRCB</b>	\$231.73
2½ x .080 x 10mm	<b>S-02508SDCRCB</b>	\$266.67
2¾ x .080 x 10mm	<b>S-02708SDCRCB</b>	\$271.84
2⅞ x .080 x 10mm	S-02808SDCRCB	\$273.86

Size	Part #	List Price
3 x .080 x 10mm	<b>S-03008SDCRCB</b>	\$276.00
3½ x .080 x 10mm	<b>S-03508SDCRCB</b>	\$365.57
4 x .080 x 10mm	<b>S-04008SDCRCB</b>	\$491.21
4¼ x .080 x 10mm	S-04208SDCRCB	\$504.58
4½ x .080 x 10mm	<b>S-04508SDCRCB</b>	\$586.96

**EXTENSION & ADAPTERS**  
CORE BITS

- Available in various threads and lengths (see below)



EXTENSIONS

EXTENSIONS

Size	Minimum OD size core bit that can be used	Part #	List Price
6" extension, ⅝-11 threads	1"	<b>DVI003</b>	\$169.99
6" extension, 1-¼-7 threads	1¼"	<b>DVI004</b>	\$219.96
2" extension, ⅝-11 threads	1"	<b>DVI005</b>	\$189.96
12" extension, 1-¼-7 threads	1¼"	<b>DVI006</b>	\$289.90



THREAD ADAPTERS

THREAD ADAPTERS

Size	Minimum OD size core bit that can be used	Part #	List Price
1-¼-7 female to ⅝-11 male	1⅞"	<b>DVI008</b>	\$209.91
⅝-11 female to 1-¼-7 male	1⅞"	<b>DVI009</b>	\$169.99
⅝-11 male to ½" shank	1"	<b>DVI033</b>	\$67.48



# HIGH SPEED • MASONRY LOW HP FLAT SAW BLADES

## HIGH SPEED PERFORMANCE CHART

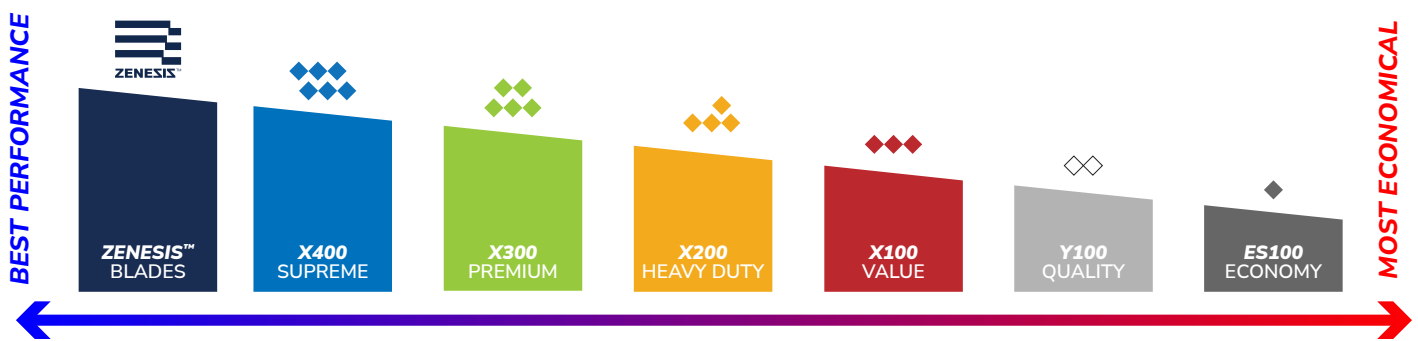

## HIGH SPEED BOND SELECTION CHART

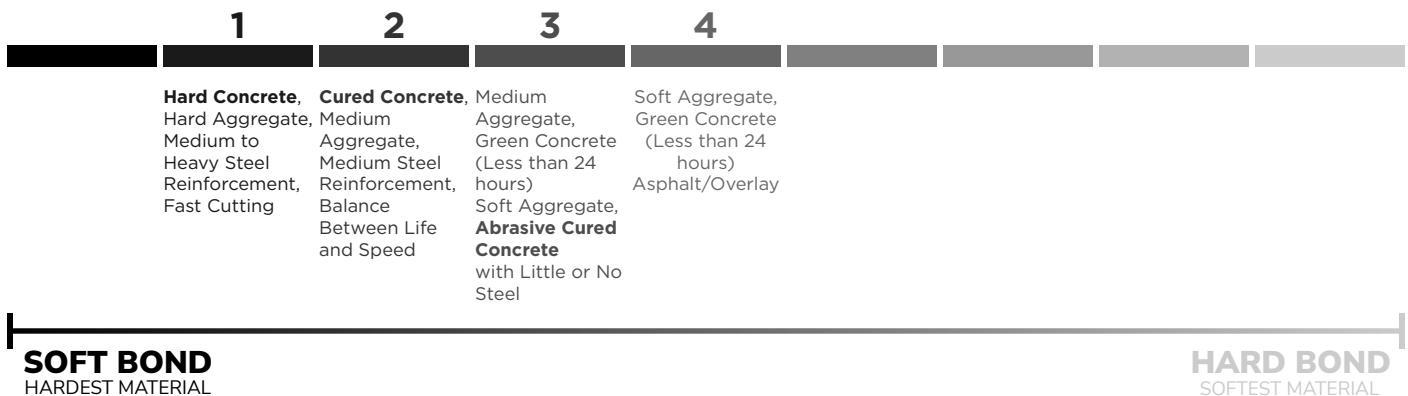

**X400 VORTEX**  
HARD MATERIALS



**SUPREME GRADE**

- 9mm (.354") rim height
- Unique turbo rim design

**APPLICATIONS** - Granite, Marble, Hard Brick, Hard Paver

Size	Part #	List Price
12 x .125 x 20mm	<b>1212BDVUX4-1</b>	\$356.84
12 x .125 x 1/20mm	<b>1212BEDVUX4-1</b>	\$356.84
14 x .125 x 20mm	<b>1412BDVUX4-1</b>	\$406.71
14 x .125 x 1/20mm	<b>1412BEDVUX4-1</b>	\$406.71

**X301 TURBO**  
HARD MATERIALS



**PREMIUM GRADE**

- 12mm (.472") segment height
- Water drop slot
- Turbo Segment

**APPLICATIONS** - Hard Concrete, Reinforced Concrete, Hard Paver Brick, Concrete Pipe, Terrazzo

Size	Part #	List Price
12 x .125 x 20mm	1212BZX3-1T	\$207.20
12 x .125 x 1/20mm	1212EZ3-1T	\$207.20
14 x .125 x 20mm	<b>1412BZX3-1T</b>	\$266.31
14 x .125 x 1/20mm	<b>1412EZ3-1T</b>	\$266.31
16 x .125 x 1/20mm	<b>1612EZ3-1T</b>	\$463.70
16 x .140 x 1/20mm	1614EZ3-1T	\$488.58

Size	Part #	List Price
18 x .125 x 1	1812EZ3-1T	\$576.76
18 x .140 x 1	1814EZ3-1T	\$604.80
20 x .125 x 1	2012EZ3-1T	\$667.05
20 x .140 x 1	<b>2014EZ3-1T</b>	\$698.12
24 x .140 x 1	2414EZ3-1T	\$928.46
24 x .155 x 1	2415EZ3-1T	\$1,015.60

**X300**  
HARD MATERIALS



**PREMIUM GRADE**

- 12mm (.472") segment height
- Water drop slot

**APPLICATIONS** - Hard Concrete, Reinforced Concrete, Hard Paver Brick, Concrete Pipe, Terrazzo

Size	Part #	List Price
12 x .110 x 1/20mm	1211EX3-1	\$194.48
12 x .125 x 20mm	1212BX3-1	\$207.20
12 x .125 x 1/20mm	<b>1212EX3-1</b>	\$207.20
14 x .110 x 1/20mm	1411EX3-1	\$251.24
14 x .125 x 20mm	1412BX3-1	\$266.31
14 x .125 x 1/20mm	<b>1412EX3-1</b>	\$266.31
16 x .125 x 1/20mm	<b>1612EX3-1</b>	\$463.70

Size	Part #	List Price
16 x .140 x 1	1614EX3-1	\$488.58
18 x .125 x 1	<b>1812EX3-1</b>	\$576.76
18 x .140 x 1	1814EX3-1	\$604.80
20 x .125 x 1	<b>2012EX3-1</b>	\$667.05
20 x .140 x 1	<b>2014EX3-1</b>	\$698.12
24 x .140 x 1	<b>2414EX3-1</b>	\$928.46
24 x .155 x 1	<b>2415EX3-1</b>	\$1,015.60

**X101 TURBO**  
HARD MATERIALS



◆◆◆ VALUE GRADE

- 12mm (.472") segment height
- Keyhole slot
- Alternating Turbo segments
- Made in USA

**APPLICATIONS** - Hard Concrete, Reinforced Concrete, Hard Paver Brick, Concrete Pipe, Terrazzo

Size	Part #	List Price
12 x .125 x 20mm	1212BLZX1-1	\$173.16
12 x .125 x 1/20mm	1212ELZX1-1	\$173.16
14 x .125 x 20mm	<b>1412BLZX1-1</b>	\$217.72
14 x .125 x 1/20mm	<b>1412ELZX1-1</b>	\$217.72
16 x .125 x 20mm	1612BLZX1-1	\$306.23
16 x .125 x 1/20mm	1612ELZX1-1	\$306.23
18 x .125 x 1	1812ELZX1-1	\$549.10

**Y110**  
HARD MATERIALS



◇◇◇ QUALITY GRADE

- 12mm (.472") segment height
- Keyhole slot

**APPLICATIONS** - Hard Concrete, Reinforced Concrete, Hard Paver Brick, Concrete Pipe, Terrazzo

Size	Part #	List Price
12 x .125 x 20mm	1212BY1-1	\$157.44
12 x .125 x 1/20mm	1212EY1-1	\$157.44
14 x .125 x 20mm	1412BY1-1	\$196.82
14 x .125 x 1/20mm	<b>1412EY1-1</b>	\$196.82
16 x .125 x 1/20mm	1612EY1-1	\$324.71

**X400**  
REFRACTORY



◆◆◆ SUPREME GRADE

- 10mm (.394") segment height
- Slanted Wide U Slot

**APPLICATIONS** - Hard Concrete, Reinforced Concrete, Hard Paver Brick, Concrete Pipe, Terrazzo

Size	Part #	List Price
12 x .110 x 1/20mm	1211EX4-1E	\$323.03
12 x .125 x 20mm	1212BX4-1E	\$345.03
12 x .125 x 1/20mm	1212EX4-1E	\$345.03
14 x .110 x 1/20mm	1411EX4-1E	\$394.81
14 x .125 x 20mm	1412BX4-1E	\$416.82
14 x .125 x 1/20mm	1412EX4-1E	\$416.82
16 x .125 x 1/20mm	1612EX4-1E	\$516.63
18 x .125 x 1	1812EX4-1E	\$632.81
20 x .125 x 1	2012EX4-1E	\$731.36
24 x .155 x 1	2415EX4-1E	\$1,047.76

PART #'S IN BOLD INDICATE ROUTINELY STOCKED PRODUCTS



**X100**  
REFRACTORY



◆◆◆ **VALUE GRADE**

- 10mm (.394") segment height
- Slanted Wide U Slot

**APPLICATIONS** - Hard Concrete, Reinforced Concrete, Hard Paver Brick, Concrete Pipe, Terrazzo

Size	Part #	List Price
12 x .110 x 1/20mm	1211EX1-1E	\$196.84
12 x .125 x 20mm	1212BX1-1E	\$206.09
12 x .125 x 1/20mm	1212EX1-1E	\$206.09
14 x .110 x 1/20mm	<b>1411EX1-1E</b>	\$254.72
14 x .125 x 20mm	1412BX1-1E	\$266.31
14 x .125 x 1/20mm	<b>1412EX1-1E</b>	\$266.31
16 x .125 x 1/20mm	1612EX1-1E	\$370.38
18 x .125 x 1	1812EX1-1E	\$487.99
20 x .125 x 1	2012EX1-1E	\$550.25

**ZENESIS™ V-SERIES**  
GENERAL PURPOSE



**ZENESIS™ GRADE**

- 15mm (.590") segment height
- ZENESIS™ Pattern Diamond Technology for maximum performance and consistency from blade to blade
- Hybrid Layering Technology maximizes exposed diamonds
- Unique V-notch segment design
- Significantly improves both cutting speed and blade life

**APPLICATIONS** - Cured Concrete, Brick, Block

Size	Part #	List Price
12 x .125 x 1/20mm	1212BEDUZX5-2V	\$553.02
14 x .125 x 20mm	1412BDUZX5-2V	\$672.87
14 x .125 x 1/20mm	1412BEDUZX5-2V	\$672.87
16 x .125 x 1/20mm	1612BEDUZX5-2V	\$792.72
18 x .125 x 1	1812EDUZX5-2V	\$926.22
20 x .125 x 1	2012EDUZX5-2V	\$1,078.77
24 x .125 x 1	2412EDUZX5-2V	\$1,501.08

**X400 VORTEX**  
GENERAL PURPOSE



◆◆◆ **SUPREME GRADE**

- 9mm (.354") rim height
- Unique Vortex Turbo design for fast, smooth cutting

**APPLICATIONS** - Reinforced Concrete, Brick, Block, Concrete Roofing Tile, Clay Roofing Tile, Landscaping Stone

Size	Part #	List Price
12 x .125 x 20mm	1212BDVUX4-2	\$334.05
12 x .125 x 1/20mm	<b>1212BEDVUX4-2</b>	\$334.05
14 x .125 x 20mm	1412BDVUX4-2	\$380.77
14 x .125 x 1/20mm	<b>1412BEDVUX4-2</b>	\$380.77

**X350**  
GENERAL PURPOSE



**PREMIUM GRADE**

- 12mm (.472") segment height
- Slanted Keyhole slot

**APPLICATIONS** - Reinforced Concrete, Brick, Block, Cured Concrete

Size	Part #	List Price
12 x .125 x 20mm	1212BX3.5-2	\$263.97
12 x .125 x 1/20mm	<b>1212EX3.5-2</b>	\$263.97
12 x 187 x 1	1218EX3.5-2	\$514.86
12 x .250 x 1	1225EX3.5-2	\$544.18
12 x .375 x 1	1237EX3.5-2	\$915.38
12 x .500 x 1	1250EX3.5-2	\$1,041.17
14 x .110 x 1/20mm	1411EX3.5-2	\$270.74
14 x .125 x 20mm	<b>1412BX3.5-2</b>	\$329.97
14 x .125 x 1/20mm	<b>1412EX3.5-2</b>	\$329.97
14 x .187 x 1	1418EX3.5-2	\$543.02
14 x .250 x 1	1425EX3.5-2	\$725.93

Size	Part #	List Price
14 x .375 x 1	1437EX3.5-2	\$1,132.74
14 x .500 x 1	1450EX3.5-2	\$1,338.66
16 x .125 x 20mm	1612BX3.5-2	\$428.43
16 x .125 x 1/20mm	<b>1612EX3.5-2</b>	\$428.43
16 x .140 x 1/20mm	1614EX3.5-2	\$449.22
16 x .250 x 1	1625EX3.5-2	\$860.25
18 x .125 x 1	<b>1812EX3.5-2</b>	\$534.25
18 x .140 x 1	<b>1814EX3.5-2</b>	\$558.08
18 x .250 x 1	1825EX3.5-2	\$1,389.37
20 x .125 x 1	<b>2012EX3.5-2</b>	\$620.33
20 x .140 x 1	<b>2014EX3.5-2</b>	\$647.32

**Y121 TURBO**  
GENERAL PURPOSE



**QUALITY GRADE**

- 15mm (.591") segment height
- Slanted U slot
- Alternating Turbo segment

**APPLICATIONS** - Reinforced Concrete, Brick, Block, Cured Concrete

Size	Part #	List Price
12 x .125 x 1/20mm	<b>1212EYZ-15</b>	\$231.56
14 x .125 x 20mm	<b>1412BYZ-15</b>	\$289.45
14 x .125 x 1/20mm	<b>1412EYZ-15</b>	\$289.45
16 x .125 x 1/20mm	<b>1612EYZ-15</b>	\$373.46
20 x .140 x 1	<b>2014EYZ-15</b>	\$622.44

**Y111 TURBO**  
GENERAL PURPOSE



**QUALITY GRADE**

- 12mm (.472") segment height
- Keyhole slot
- Segmented turbo for balance between life and speed of cut

**APPLICATIONS** - Reinforced Concrete, Brick, Block, Cured Concrete

Size	Part #	List Price
12 x .125 x 20mm	<b>1212BDZUY2-2KV</b>	\$157.44
12 x .125 x 1/20mm	<b>1212BEDZUY2-2KV</b>	\$157.44
14 x .125 x 20mm	<b>1412BDZUY2-2KV</b>	\$196.82
14 x .125 x 1/20mm	<b>1412BEDZUY2-2KV</b>	\$196.82
16 x .125 x 1/20mm	<b>1612BEDZUY2-2KV</b>	\$370.50
18 x .125 x 1	<b>1812EDZUY2-2KV</b>	\$470.13
20 x .140 x 1	<b>2014EDZUY2-2KV</b>	\$521.05

**Y110**  
GENERAL PURPOSE



◇◇ QUALITY GRADE

- 12mm (.472") segment height
- Keyhole slot
- One step up from our Y100 model with longer life and faster cutting
- Made in USA

**APPLICATIONS** - Reinforced Concrete, Brick, Block, Cured Concrete

Size	Part #	List Price
12 x .125 x 20mm	<b>1212BY1-2</b>	\$157.44
12 x .125 x 1/20mm	<b>1212EY1-2</b>	\$157.44
14 x .110 x 1/20mm	1411EY1-2	\$179.41
14 x .125 x 20mm	<b>1412BY1-2</b>	\$196.82
14 x .125 x 1/20mm	<b>1412EY1-2</b>	\$196.82
16 x .125 x 20mm	1612BY1-2	\$324.71
16 x .125 x 1/20mm	<b>1612EY1-2</b>	\$324.71
18 x .125 x 1	<b>1812EY1-2</b>	\$421.19
20 x .140 x 1	<b>2014EY1-2</b>	\$497.93

**Y100**  
GENERAL PURPOSE



◇◇ QUALITY GRADE

- 12mm (.472") segment height
- Keyhole slot
- Made in USA

**APPLICATIONS** - Reinforced Concrete, Brick, Block, Cured Concrete

Size	Part #	List Price
12 x .125 x 20mm	<b>1212BLY1-2</b>	\$138.76
12 x .125 x 1/20mm	<b>1212ELY1-2</b>	\$138.76
14 x .125 x 20mm	<b>1412BLY1-2</b>	\$151.26
14 x .125 x 1/20mm	<b>1412ELY1-2</b>	\$151.26
16 x .125 x 20mm	1612BLY1-2	\$226.11
16 x .125 x 1/20mm	1612ELY1-2	\$226.11
18 x .125 x 1	1812ELY1-2	\$479.47

**ES101 TURBO**  
GENERAL PURPOSE



◆ ECONOMY GRADE

- 12mm (.472") segment height
- Keyhole slot
- Turbo segments
- Sintered

**APPLICATIONS** - Reinforced Concrete, Brick, Block, Cured Concrete

Size	Part #	List Price
12 x .125 x 20mm	1212BSIZ	\$121.59
12 x .125 x 1/20mm	<b>1212ESIZ</b>	\$121.59
14 x .125 x 20mm	<b>1412BSIZ</b>	\$133.15
14 x .125 x 1/20mm	<b>1412ESIZ</b>	\$133.15



**ES101**

GENERAL PURPOSE



◆ **ECONOMY GRADE**

- 12mm (.472") segment height
- Keyhole slot
- Sintered

**APPLICATIONS** - Reinforced Concrete, Brick, Block, Cured Concrete

Size	Part #	List Price
12 x .125 x 20mm	<b>1212BSI</b>	\$121.56
12 x .125 x 1/20mm	<b>1212ESI</b>	\$121.56
14 x .125 x 20mm	<b>1412BSI</b>	\$133.15
14 x .125 x 1/20mm	<b>1412ESI</b>	\$133.15

**X300**

ABRASIVE MATERIALS



◆◆ **PREMIUM GRADE**

- 12mm (.472") segment height
- Water drop slot

**APPLICATIONS** - Concrete Block, Lightweight Concrete Block, Sand Stone, Lime Stone

Size	Part #	List Price
12 x .125 x 1	<b>1212EX3-3</b>	\$265.14
14 x .125 x 1	<b>1412EX3-3</b>	\$329.97
16 x .125 x 1	<b>1612EX3-3</b>	\$444.44
18 x .125 x 1	<b>1812EX3-3</b>	\$534.72
20 x .125 x 1	<b>2012EX3-3</b>	\$622.91
20 x .140 x 1	<b>2014EX3-3</b>	\$643.69
24 x .140 x 1	2414EX3-3	\$897.04
24 x .155 x 1	<b>2415EX3-3</b>	\$1,012.32

**Y100**

ABRASIVE MATERIALS



◇◇ **QUALITY GRADE**

- 10mm (.394") segment height
- Keyhole slot
- Recommended for 5-13HP saws
- Made in USA

**APPLICATIONS** - Abrasive Concrete, Soft/Abrasive Aggregates, Green Concrete

Size	Part #	List Price
12 x .125 x 1	1212EY2-3	\$180.80
14 x .125 x 1	1412EY2-3	\$226.71

**X400**  
ASPHALT



**SUPREME GRADE**

- 10mm (.394") segment height
- Keyhole slot
- Equipped with wedge segment undercut protection

**APPLICATIONS** - Asphalt, Green Concrete

Size	Part #	List Price
12 x .110 x 1/20mm	1211EX4-4	\$420.25
12 x .125 x 20mm	1212BX4-4	\$465.46
12 x .125 x 1/20mm	1212EX4-4	\$465.46
14 x .110 x 1/20mm	1411EX4-4	\$522.22
14 x .125 x 20mm	1412BX4-4	\$578.87
14 x .125 x 1/20mm	<b>1412EX4-4</b>	\$578.87
14 x .187 x 1	1418EX4-4	\$1,058.11

Size	Part #	List Price
14 x .250 x 1	1425EX4-4	\$1,058.11
14 x .375 x 1	1437EX4-4	\$1,540.50
16 x .125 x 1/20mm	1612EX4-4	\$659.82
16 x .140 x 1	1614EX4-4	\$716.81
18 x .125 x 1	<b>1812EX4-4</b>	\$785.31
20 x .125 x 1	2012EX4-4	\$898.38

**X100**  
ASPHALT



**VALUE GRADE**

- 8mm (.315") segment height
- U slot
- Equipped with insert undercut protection

**APPLICATIONS** - Asphalt, Green Concrete

Size	Part #	List Price
12 x .110 x 1/20mm	1211EX1-4	\$313.73
12 x .125 x 20mm	1212BX1-4	\$341.53
12 x .125 x 1/20mm	1212EX1-4	\$341.53
14 x .110 x 20mm	<b>1411BX1-4</b>	\$333.48
14 x .110 x 1/20mm	1411EX1-4	\$333.48
14 x .125 x 20mm	1412BX1-4	\$397.13
14 x .125 x 1/20mm	<b>1412EX1-4</b>	\$397.13
16 x .125 x 1/20mm	<b>1612EX1-4</b>	\$416.05

**Y110**  
ASPHALT



**QUALITY GRADE**

- 12mm (.472") segment height
- U slot deep segment

**APPLICATIONS** - Asphalt, Green Concrete

Size	Part #	List Price
12 x .125 x 1/20mm	1212EY2-4T	\$207.67
14 x .125 x 1/20mm	<b>1412EY2-4T</b>	\$254.74
16 x .125 x 1/20mm	1612EY2-4T	\$342.69
18 x .125 x 1	<b>1812EY2-4T</b>	\$456.93

**ES100**  
ASPHALT



**NEW**

**ZENESIS™ AP3**  
ALL PURPOSE



**ZENESIS™ V-SERIES**  
ALL PURPOSE



◆ **ECONOMY GRADE**

- 10mm (.394") or 12mm (.472") segment height
- U slot, equipped with wedge segment undercut protection

**APPLICATIONS** - Asphalt, Green Concrete

Size	Part #	List Price
14" x .125 x 1/20mm, 10mm	<b>1412ESIT-4</b>	\$169.31
14" x .125 x 1/20mm, 12mm	<b>1412ESI-4</b>	\$177.48



**ZENESIS™ GRADE**

- 14mm (.551") segment height
- Unique segment design on drop segment
- ZENESIS™ Pattern Diamond Technology for maximum performance and consistency from blade to blade

**APPLICATIONS** - Asphalt, Cured Concrete, Abrasive Concrete, Green Concrete, Brick/Block

Size	Part #	List Price
12 x .125 x 20mm	1212BDUZX4-AP3	\$419.64
14 x .125 x 20mm	1412BDUZX4-AP3	\$500.57
14 x .125 x 1/20mm	1412BEDUZX4-AP3	\$500.57
16 x .125 x 1/20mm	1612BEDUZX4-AP3	\$616.72
18 x .140 x 1/20mm	1814EDUZX4-AP3	\$857.64
20 x .140 x 1/20	2014EDUZX4-AP3	\$869.53
24 x .140 x 1/20mm	2414EDUZX4-AP3	\$1,239.85



**ZENESIS™ GRADE**

- 15mm (.591") segment height
- Slanted keyhole slot, equipped with deep segment undercut protection
- ZENESIS™ Pattern Diamond Technology for maximum performance and consistency from blade to blade

**APPLICATIONS** - Asphalt, Reinforced Concrete, Brick, Block, Cured Concrete

Size	Part #	List Price
12 x .125 x 20mm	1212BDUZX4-AP2	\$457.68
12 x .125 x 1/20mm	1212BEDUZX4-AP2	\$457.68
14 x .125 x 20mm	<b>1412BDUZX4-AP2</b>	\$476.73
14 x .125 x 1/20mm	<b>1412BEDUZX4-AP2</b>	\$476.73
16 x .125 x 20mm	1612BDUZX4-AP2	\$587.36
16 x .125 x 1/20mm	<b>1612BEDUZX4-AP2</b>	\$587.36
18 x .125 x 1	<b>1812EDUZX4-AP2</b>	\$683.65



**AP300**  
ALL PURPOSE



**PREMIUM GRADE**

- 10mm (.394") segment height
- Slanted T slot, equipped with wedge segment undercut protection

**APPLICATIONS** - Asphalt, Reinforced Concrete, Brick, Block, Cured Concrete

Size	Part #	List Price
12 x .110 x 1/20mm	1211BEDUX3-AP	\$362.44
12 x .125 x 20mm	1212BDUX3-AP	\$382.06
12 x .125 x 1/20mm	<b>1212BEDUX3-AP</b>	\$382.06
14 x .125 x 20mm	<b>1412BDUX3-AP</b>	\$463.13
14 x .125 x 1/20mm	<b>1412BEDUX3-AP</b>	\$463.13
16 x .125 x 20mm	1612BDUX3-AP	\$497.93
16 x .125 x 1/20mm	<b>1612BEDUX3-AP</b>	\$497.93
18 x .125 x 1	<b>1812EDUX3-AP</b>	\$758.40

**AP201 TURBO**  
ALL PURPOSE



**HEAVY DUTY GRADE**

- 15mm (.591") segment height
- Slanted U slot, alternating turbo & equipped with wedge segment undercut protection
- Alternating turbo segments for faster cutting

**APPLICATIONS** - Asphalt, Reinforced Concrete, Brick, Block, Cured Concrete

Size	Part #	List Price
12 x .125 x 1/20mm	<b>1212EYZ-AP</b>	\$259.30
14 x .125 x 20mm	<b>1412BYZ-AP</b>	\$324.24
14 x .125 x 1/20mm	<b>1412EYZ-AP</b>	\$324.24
16 x .125 x 1/20mm	<b>1612EYZ-AP</b>	\$552.24
18 x .125 x 1	<b>1812EYZ-AP</b>	\$701.28

**AP200**  
ALL PURPOSE



**HEAVY DUTY GRADE**

- 10mm (.394") segment height
- Slanted T slot, equipped with deep segment undercut protection

**APPLICATIONS** - Asphalt, Reinforced Concrete, Brick, Block, Cured Concrete

Size	Part #	List Price
14 x .125 x 20mm	<b>1412BX1-AP</b>	\$347.37
14 x .125 x 1/20mm	<b>1412EX1-AP</b>	\$347.37
16 x .125 x 1/20mm	<b>1612EX1-AP</b>	\$441.33
18 x .125 x 1/20mm	<b>1812EX1-AP</b>	\$487.63
20 x .125 x 1/20mm	<b>2012EX1-AP</b>	\$582.99

### AP100 COMBO CUT

ALL PURPOSE



### ◇◇ QUALITY GRADE

- 12mm (.472") segment height
- Slanted U slot, equipped with deep segment undercut protection
- Alternating turbo segments for faster cutting
- Made in USA

**APPLICATIONS** - Asphalt, Reinforced Concrete, Brick, Block, Cured Concrete

Size	Part #	List Price
12 x .125 x 20mm	<b>1212BLY2-AP</b>	\$193.55
12 x .125 x 1/20mm	<b>1212ELY2-AP</b>	\$193.55
14 x .125 x 20mm	<b>1412BLY2-AP</b>	\$232.93
14 x .125 x 1/20mm	<b>1412ELY2-AP</b>	\$232.93
16 x .125 x 1/20mm	<b>1612ELY2-AP</b>	\$352.03
18 x .125 x 1	1812ELY2-AP	\$514.88
20 x .125 x 1	2012ELY2-AP	\$743.72

### X200-AC

METAL CUTTING



### ◆◆ HEAVY DUTY GRADE

- 5mm (.196") segment height
- Brazed segment, cooling hole

**APPLICATIONS** - PVC Pipe, Steel, Cast Iron, Ductile Iron Pipe, Reinforced Concrete

Size	Part #	List Price
12 x .142 x 20mm	1214BDUX2-AC2	\$281.61
12 x .142 x 1/20mm	1214BEDUX2-AC2	\$281.61
14 x .142 x 20mm	<b>1414BDUX2-AC2</b>	\$323.30
14 x .142 x 1/20mm	<b>1414BEDUX2-AC2</b>	\$323.30
16 x .145 x 1/20mm	<b>1614BEDUX2-AC2</b>	\$417.10
18 x .145 x 1	1814EDUX2-AC2	\$625.71
20 x .155 x 1	2015EDUX2-AC2	\$743.68

### X400

DUCTILE IRON



### ◆◆ SUPREME GRADE

- 4mm (.157") segment height
- Turbo segment

**APPLICATIONS** - Ductile Iron, Concrete Water Mains

Size	Part #	List Price
12 x .110 x 1/20mm	<b>1211BEDDIX4-4</b>	\$323.65
12 x .125 x 1/20mm	<b>1212BEDDIX4-4</b>	\$367.22
14 x .110 x 1/20mm	<b>1411BEDDIX4-4</b>	\$376.57
14 x .125 x 1/20mm	<b>1412BEDDIX4-4</b>	\$463.70
16 x .125 x 1/20mm	<b>1612BEDDIX4-4</b>	\$509.37

# EARLY ENTRY GREEN CONCRETE

## THE ZENESIS™ EARLY ENTRY GREEN CONCRETE CUTTING SYSTEM

The ZENESIS™ GREEN early entry green concrete cutting system features a ninja arbor that easily fits Soff-Cut® saws without adapters. Color-coded blades maximize life and cutting speed for different aggregate conditions.

### EARLY ENTRY BOND SELECTION CHART

Choose the ZENESIS™ GREEN early entry bond that matches your aggregate and cutting conditions.

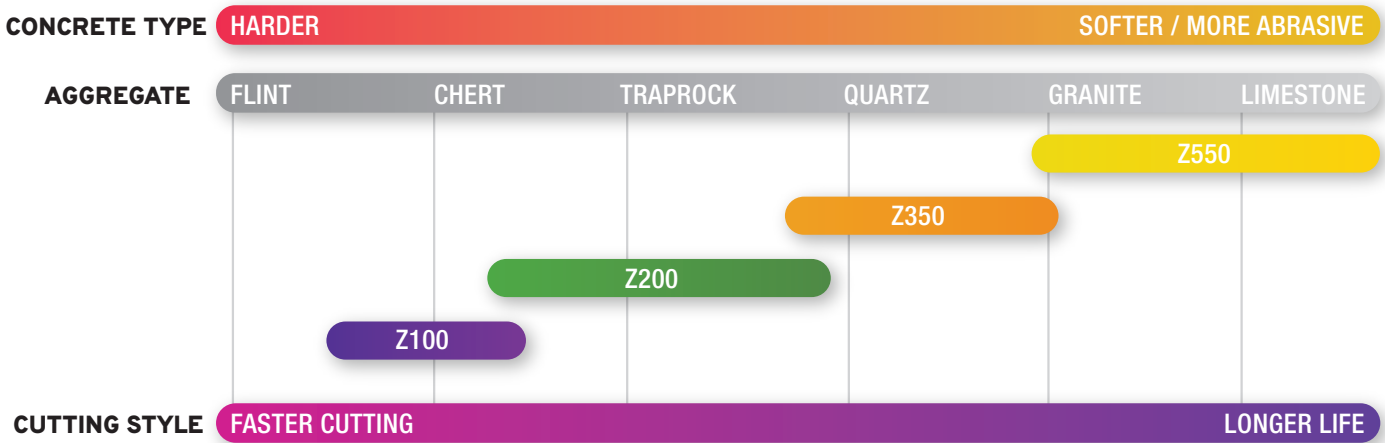

### REFERENCE CHARTS

CROSS REFERENCE CHART

SOFF-CUT®	EZ GREEN
1000 - PURPLE	Z100
2000 - GREEN	Z200
4000 - ORANGE	Z350
5000 - YELLOW 6000 - BLACK	Z550

SAW REFERENCE CHART

MODEL **	BLADE SIZE
X-50	5"
X-390	5.5"
X-150	6"
X-450, X-750, GX-1000	8"
X-2000, X-2500	10"
X-4000, X-4200	12" & 13.5"
X-5000	12" & 14"

\*SOFF-CUT® IS A REGISTERED TRADEMARK OF HUSQVARNA AB. DIAMOND VANTAGE® IS NOT AFFILIATED WITH HUSQVARNA AB.

\*\*SAW MODEL NUMBERS ARE IN REFERENCE TO HUSQVARNA SAWS



**Z100 PURPLE**  
GREEN CONCRETE



**ZENESIS™ GRADE**

- 10mm (.394") segment height
- Comparable to Soff-Cut® 1000
- ZENESIS™ Pattern Diamond Technology

**APPLICATIONS** - Very Hard Aggregate, Flint, Chert

Size	Part #	List Price
5 x .080 x EZ- $\frac{5}{8}$	0508EZ100Z	\$182.53
5½ x .080 x EZ- $\frac{5}{8}$	5508EZ100Z	\$206.39
6 x .095 x EZ-1	<b>0609EZ100Z</b>	\$264.85
6 x .225 x EZ-1	0622EZ100Z	\$528.49
8 x .095 x EZ- $\frac{7}{8}$ - $\frac{5}{8}$	0809EZ100Z	\$350.75
8 x .225 x EZ- $\frac{7}{8}$ - $\frac{5}{8}$	0822EZ100Z	\$720.58
10 x .095 x EZ- $\frac{7}{8}$ - $\frac{5}{8}$	<b>1009EZ100Z</b>	\$476.48

Size	Part #	List Price
10 x .250 x EZ- $\frac{7}{8}$ - $\frac{5}{8}$	1025EZ100Z	\$949.62
12 x .125 x EZ-1	<b>1212EZ100Z</b>	\$688.36
12 x .250 x EZ-1	1225EZ100Z	\$1,193.00
13½ x .125 x EZ-1	1312EZ100Z	\$786.18
13½ x .250 x EZ-1	<b>1325EZ100Z</b>	\$1,312.31
14 x .125 x EZ-1	<b>1412EZ100Z</b>	\$786.18
14 x .250 x EZ-1	1425EZ100Z	\$1,312.31

**Z200 GREEN**  
GREEN CONCRETE



**ZENESIS™ GRADE**

- 10mm (.394") segment height
- Comparable to Soff-Cut® 2000
- ZENESIS™ Pattern Diamond Technology

**APPLICATIONS** - Medium to Hard Chert, Traprock

Size	Part #	List Price
5 x .080 x EZ- $\frac{5}{8}$	0508EZ200Z	\$182.53
5½ x .080 x EZ- $\frac{5}{8}$	5508EZ200Z	\$206.39
6 x .095 x EZ-1	<b>0609EZ200Z</b>	\$264.85
6 x .225 x EZ-1	0622EZ200Z	\$528.49
8 x .095 x EZ- $\frac{7}{8}$ - $\frac{5}{8}$	0809EZ200Z	\$350.75
8 x .225 x EZ- $\frac{7}{8}$ - $\frac{5}{8}$	0822EZ200Z	\$720.58
10 x .095 x EZ- $\frac{7}{8}$ - $\frac{5}{8}$	<b>1009EZ200Z</b>	\$476.48

Size	Part #	List Price
10 x .250 x EZ- $\frac{7}{8}$ - $\frac{5}{8}$	1025EZ200Z	\$949.62
12 x .125 x EZ-1	<b>1212EZ200Z</b>	\$688.36
12 x .250 x EZ-1	1225EZ200Z	\$1,193.00
13½ x .125 x EZ-1	1312EZ200Z	\$786.18
13½ x .250 x EZ-1	1325EZ200Z	\$1,312.31
14 x .125 x EZ-1	1412EZ200Z	\$786.18
14 x .250 x EZ-1	1425EZ200Z	\$1,312.31

**Z350 ORANGE**  
GREEN CONCRETE



**ZENESIS™ GRADE**

- 10mm (.394") segment height
- Comparable to Soff-Cut® 3000 & 4000
- ZENESIS™ Pattern Diamond Technology

**APPLICATIONS** - Medium Traprock, Quartz

Size	Part #	List Price
5 x .080 x EZ- $\frac{5}{8}$	0508EZ350Z	\$182.53
5½ x .080 x EZ- $\frac{5}{8}$	5508EZ350Z	\$206.39
6 x .095 x EZ-1	<b>0609EZ350Z</b>	\$264.85
6 x .225 x EZ-1	0622EZ350Z	\$528.49
8 x .095 x EZ- $\frac{7}{8}$ - $\frac{5}{8}$	<b>0809EZ350Z</b>	\$350.75
8 x .225 x EZ- $\frac{7}{8}$ - $\frac{5}{8}$	0822EZ350Z	\$720.58
10 x .095 x EZ- $\frac{7}{8}$ - $\frac{5}{8}$	<b>1009EZ350Z</b>	\$476.48

Size	Part #	List Price
10 x .250 x EZ- $\frac{7}{8}$ - $\frac{5}{8}$	1025EZ350Z	\$949.62
12 x .125 x EZ-1	<b>1212EZ350Z</b>	\$688.36
12 x .250 x EZ-1	1225EZ350Z	\$1,193.00
13½ x .125 x EZ-1	<b>1312EZ350Z</b>	\$786.18
13½ x .250 x EZ-1	<b>1325EZ350Z</b>	\$1,312.31
14 x .125 x EZ-1	1412EZ350Z	\$786.18
14 x .250 x EZ-1	1425EZ350Z	\$1,312.31

**Z550 YELLOW**  
GREEN CONCRETE



**NEW**  
**ZENESIS™ EXTREME GREEN**  
GREEN CONCRETE



**ZENESIS™ V-SERIES**  
CURED CONCRETE



**ZENESIS™ GRADE**

- 10mm (.394") segment height
- Comparable to Soff-Cut® 5000 & 6000
- ZENESIS™ Pattern Diamond Technology

**APPLICATIONS** - Soft Granite, Limestone

Size	Part #	List Price
5 x .080 x EZ-½	0508EZ550Z	\$182.53
5½ x .080 x EZ-½	5508EZ550Z	\$206.39
6 x .095 x EZ-1	<b>0609EZ550Z</b>	\$264.85
6 x .225 x EZ-1	0622EZ550Z	\$528.49
8 x .095 x EZ-7/8-¾	0809EZ550Z	\$350.75
8 x .225 x EZ-7/8-¾	0822EZ550Z	\$720.58
10 x .095 x EZ-7/8-¾	1009EZ550Z	\$476.48

Size	Part #	List Price
10 x .250 x EZ-7/8-¾	1025EZ550Z	\$949.62
12 x .125 x EZ-1	1212EZ550Z	\$688.36
12 x .250 x EZ-1	1225EZ550Z	\$1,193.00
13½ x .125 x EZ-1	<b>1312EZ550Z</b>	\$786.18
13½ x .250 x EZ-1	1325EZ550Z	\$1,312.31
14 x .125 x EZ-1	1412EZ550Z	\$786.18
14 x .250 x EZ-1	1425EZ550Z	\$1,312.31



**ZENESIS™ GRADE**

- 12mm (.472") Segment Height
- ZENESIS™ Pattern Diamond Technology for maximum performance and consistency from blade to blade
- Also available with Soff-Cut® arbor

**APPLICATIONS** - Green Concrete

Size	Part #	List Price
6 x .095 x 1	0609KDGZX4	\$270.34
8 x .095 x 7/8	0809CDGZX4	\$457.17
10 x .095 x 7/8	1009CDGZX4	\$662.87
12 x .125 x 1	1212KDGZX4	\$1,044.65
13½ x .125 x 1	1312KDGZX4	\$1,231.86
14 x .125 x 1	1412KDGZX4	\$1,251.71



**ZENESIS™ GRADE**

- 12mm (.472") segment height, available in 4"-8" blades sizes
- ZENESIS™ Pattern Diamond Technology for maximum performance and consistency from blade to blade
- Hybrid Layering Technology maximizes exposed diamonds
- Unique V-notch segment design
- Significantly improves both cutting speed and blade life
- 9" blade: specifically designed for battery powered saw

**APPLICATIONS** - Cured Concrete, Brick, Block

Size	Part #	List Price
8 x .094 x U/A	0809UDUZK5-2V	\$223.40
10 x .094 x U/A	1009UDUZK5-2V	\$343.25

**X300**  
GREEN CONCRETE



**PREMIUM GRADE**

- 12mm (.472") segment height
- Also available with Soff-Cut® arbor

**APPLICATIONS** - Very Hard Aggregate, Flint, Chert

Size	Part #	List Price
5 x .080 x EZ	0508EZGX3	\$226.95
5 x .080 x ½	0508ADGX3	\$226.95
6 x .095 x EZ	0609EZGX3	\$254.74
6 x .095 x ½	<b>0609ADGX3</b>	\$254.74
6 x .095 x ¾-5/8	<b>0609CDGX3</b>	\$254.74
6½ x .095 x EZ	6509EZGX3	\$332.35
7 x .095 x ½	<b>0709ADGX3</b>	\$389.06
7 x .095 x U/A	<b>0709UDGX3</b>	\$389.06
8 x .095 x EZ	0809EZGX3	\$429.59
8 x .095 x ½	<b>0809ADGX3</b>	\$429.59
8 x .095 x ¾	<b>0809CDGX3</b>	\$429.59
8 x .250 x EZ	0825EZGX3	\$533.96

Size	Part #	List Price
9 x .095 x ¾	<b>0909ADGX3</b>	\$516.38
9 x .095 x ¾-5/8	<b>0909CDGX3</b>	\$516.38
10 x .095 x EZ	1009EZGX3	\$585.88
10 x .095 x ½	<b>1009ADGX3</b>	\$585.88
10 x .095 x 1/20mm	<b>1009EDGX3</b>	\$585.88
10 x .250 x EZ	1025EZGX3	\$1,092.06
12 x .125 x EZ	1212EZGX3	\$700.34
12 x .250 x EZ	1225EZGX3	\$1,371.95
13½ x .125 x EZ	1312EZGX3	\$873.87
13½ x .250 x EZ	1325EZGX3	\$1,472.71
14 x .125 x EZ	1412EZGX3	\$893.46
14 x .250 x EZ	1425EZGX3	\$1,512.00

**SKID PLATES WITH CLIP**  
EARLY ENTRY SAW



- Compatible with all Soff-Cut® saws
- Additional sizes available

Size	Part #	List Price
For 6" & 8" blades	EZPL68C	\$179.06
For 10" blades	EZPL10C	\$195.32
For 12" & 13½ blades	EZPL1213C	\$203.47
For 14" blades	EZPL14C	\$211.60

**NEW**  
**SKID PLATES**  
EARLY GORILLA SAWS



- 8" Skid plate for Gorilla Concrete Tools saws 8EE and GS100
- 10" Skid Plate for Gorilla Concrete Tools saws GS300
- 0.090 thickness
- Pinless

Size	Part #	List Price
For 8" blades	DV-GCT-8-54-R2	\$179.06
For 10" blades	DV-GCT-GS300-81-SP	\$179.06

PART #'S IN BOLD INDICATE ROUTINELY STOCKED PRODUCTS



# SMALL DIAMETER

## SMALL DIAMETER PERFORMANCE CHART

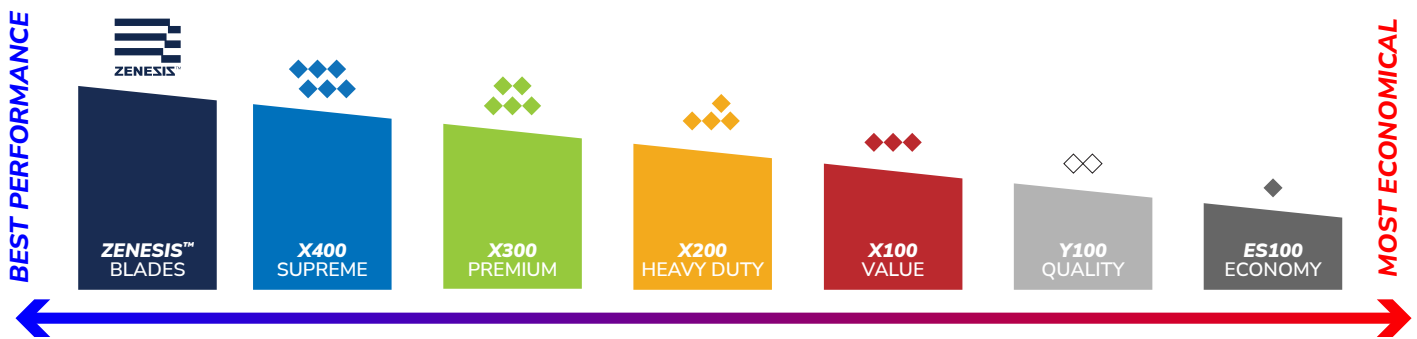

## SMALL DIAMETER BOND SELECTION CHART

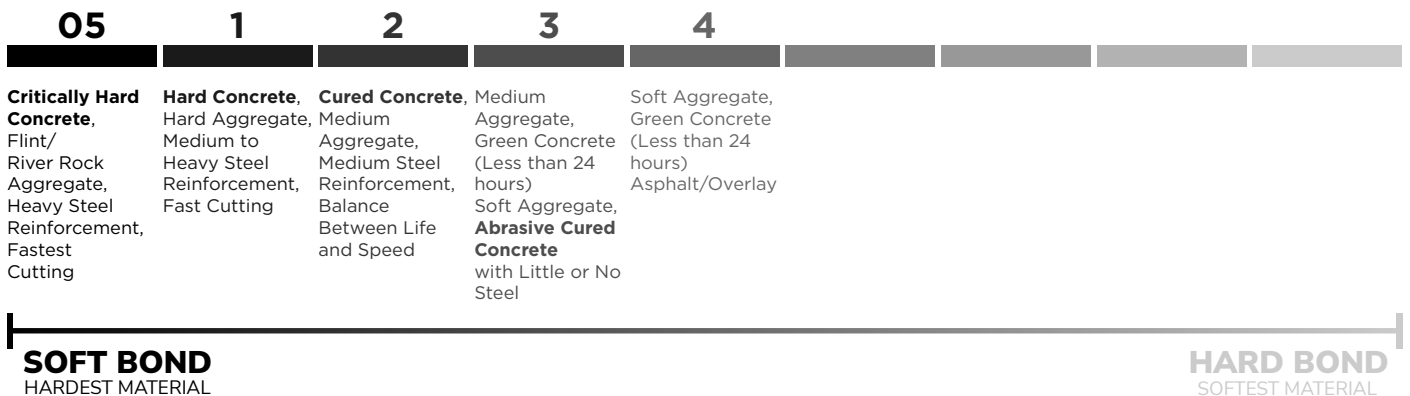

**X401 TURBO**  
HARD MATERIALS



**SUPREME GRADE**

- 10mm (.394") segment height
- Keyhole slot, turbo segment

**APPLICATIONS** - Hard Concrete, Reinforced Concrete, Hard Paver Brick

Size	Part #	List Price
4 x .080 x 7/8-5/8	0408CZ4-1	\$44.85
4 1/2 x .080 x 7/8-5/8	<b>4508CZ4-1</b>	\$47.31
5 x .080 x 7/8-5/8	0508CZ4-1	\$54.78
6 x .095 x 7/8-5/8	0609CZ4-1	\$69.03
7 x .095 x U/A	<b>0709UZ4-1</b>	\$97.30
8 x .095 x U/A	<b>0809UZ4-1</b>	\$107.46
10 x .095 x U/A	<b>1009UZ4-1</b>	\$146.59

**X400**  
HARD MATERIALS



**SUPREME GRADE**

- 10mm (.394") segment height
- Keyhole slot

**APPLICATIONS** - Hard Concrete, Reinforced Concrete, Hard Paver Brick

Size	Part #	List Price
4 x .080 x 7/8-5/8	0408CDUX4-1	\$44.85
4 1/2 x .080 x 7/8-5/8	<b>4508CDUX4-1</b>	\$47.31
5 x .080 x 7/8-5/8	<b>0508CDUX4-1</b>	\$54.78
6 x .095 x 7/8-5/8	0609CDUX4-1	\$69.03
6 x .095 x U/A	<b>0609UDUX4-1</b>	\$69.03
7 x .095 x U/A	<b>0709UDUX4-1</b>	\$97.30
8 x .095 x U/A	<b>0809UDUX4-1</b>	\$107.46
9 x .095 x DM-5/8	0909DDUX4-1	\$127.31
10 x .095 x DM-5/8	<b>1009DDUX4-1</b>	\$146.59

**X400 VORTEX**  
HARD MATERIALS



**SUPREME GRADE**

- 9mm (.354") rim height
- Unique turbo rim design

**APPLICATIONS** - Granite, Marble, Hard Brick, Hard Paver

Size	Part #	List Price
4 x .080 x 7/8-5/8	<b>0408CDZBX4-1</b>	\$79.89
4 1/2 x .080 x 7/8-5/8	<b>4508CDZBX4-1</b>	\$84.21
5 x .080 x 7/8-5/8	<b>0508CDZBX4-1</b>	\$89.47
6 x .090 x 7/8-5/8	<b>0609CDZBX4-1</b>	\$116.45
6 x .090 x U/A	<b>0609UDZBX4-1</b>	\$116.45
7 x .090 x U/A	<b>0709UDZBX4-1</b>	\$150.44
8 x .090 x U/A	<b>0809UDZBX4-1</b>	\$164.93
9 x .090 x 7/8-5/8	<b>0909CDZBX4-1</b>	\$228.23
10 x .090 x U/A	<b>1009UDZBX4-1</b>	\$230.34

**X400 PEGASUS**  
HARD MATERIALS



**SUPREME GRADE**

- 10mm (.394") segment height
- 4 hole flush cut for 4" through 7", adapter sold separately

**APPLICATIONS** - Granite, Marble, Hard Brick, Hard Pavers

Size	Part #	List Price
4 x .080 x 7/8-5/8	0408CPEGX4-1	\$56.99
4½ x .080 x 7/8-5/8	<b>4508CPEGX4-1</b>	\$60.16
5 x .080 x 7/8-5/8	<b>0508CPEGX4-1</b>	\$69.50
6 x .095 x 7/8-5/8	0609CPEGX4-1	\$97.54
7 x .095 x U/A	<b>0709UPEGX4-1</b>	\$109.91
10 x .095 x U/A	1009UPEGX4-1	\$183.62

**X200**  
HARD MATERIALS



**HEAVY DUTY GRADE**

- 10mm (.394") segment height
- Turbo rim, with cooling holes

**APPLICATIONS** - Granite, Marble, Hard Brick, Hard Pavers

Size	Part #	List Price
4 x .080 x 7/8-5/8	<b>0408CDZBX2-1</b>	\$26.86
4½ x .080 x 7/8-5/8	<b>4508CDZBX2-1</b>	\$28.74
5 x .080 x 7/8-5/8	0508CDZBX2-1	\$32.70
6 x .095 x U/A	0609UDZBX2-1	\$47.31
7 x .095 x U/A	<b>0709UDZBX2-1</b>	\$58.29
8 x .095 x U/A	0809UDZBX2-1	\$70.32
9 x .095 x U/A	0909UDZBX2-1	\$88.44
10 x .095 x U/A	1009UDZBX2-1	\$101.38

**X100**  
HARD MATERIALS



**VALUE GRADE**

- 7mm (.276") segment height
- Turbo rim, with cooling holes

**APPLICATIONS** - Granite, Marble, Hard Brick, Hard Pavers

Size	Part #	List Price
4 x .080 x 7/8-5/8	0408CDZBX1-1	\$21.14
4½ x .080 x 7/8-5/8	<b>4508CDZBX1-1</b>	\$22.43
5 x .080 x 7/8-5/8	0508CDZBX1-1	\$23.47
6 x .095 x U/A	0609UDZBX1-1	\$32.59
7 x .095 x U/A	<b>0709UDZBX1-1</b>	\$40.06



### ZENESIS™ V-SERIES

GENERAL PURPOSE



### ZENESIS™ GRADE

- 12mm (.472") segment height, available in 4"-8" blades sizes
- ZENESIS™ Pattern Diamond Technology for maximum performance and consistency from blade to blade
- Hybrid Layering Technology maximizes exposed diamonds
- Unique V-notch segment design
- Significantly improves both cutting speed and blade life
- 9" blade: specifically designed for battery powered saw

**APPLICATIONS** - Cured Concrete, Brick, Block

Size	Part #	List Price
4 x .086 x 7/8-5/8	0408CDUZX5-2V	\$87.15
4½ x .086 x 7/8-5/8	4508CDUZX5-2V	\$98.11
5 x .086 x 7/8-5/8	0508CDUZX5-2V	\$108.99
6 x .086 x U/A	0608UDUZX5-2V	\$149.79
7 x .094 x U/A	0709UDUZX5-2V	\$185.26
8 x .094 x U/A	0809UDUZX5-2V	\$223.40
9 x .094 x 7/8-5/8	0909CDUZX5-2V	\$291.48
10 x .094 x U/A	1009UDUZX5-2V	\$343.25

### X400 VORTEX

GENERAL PURPOSE



### SUPREME GRADE

- 9mm (.354") turbo rim height
- Unique vortex turbo design for fast, smooth cutting

**APPLICATIONS** - Reinforced Concrete, Brick, Block, Concrete Roofing Tile, Clay Roofing Tile, Landscaping Stone

Size	Part #	List Price
4 x .080 x 7/8-5/8	<b>0408CDZBX4-2</b>	\$75.68
4½ x .080 x 7/8-5/8	<b>4508CDZBX4-2</b>	\$85.03
5 x .080 x 7/8-5/8	<b>0508CDZBX4-2</b>	\$90.29
6 x .095 x 7/8-5/8	<b>0609CDZBX4-2</b>	\$115.17
6 x .095 x U/A	<b>0609UDZBX4-2</b>	\$115.17
7 x .095 x U/A	<b>0709UDZBX4-2</b>	\$138.99
8 x .095 x U/A	<b>0809UDZBX4-2</b>	\$152.55
9 x .095 x 7/8-5/8	0909CDZBX4-2	\$186.77
10 x .095 x U/A	<b>1009UDZBX4-2</b>	\$217.84

### X400

GENERAL PURPOSE



### SUPREME GRADE

- 10mm (.394") segment height
- Keyhole slot

**APPLICATIONS** - Reinforced Concrete, Brick, Block, Cured Concrete

Size	Part #	List Price
4 x .080 x 20mm	0408BDUX4-2	\$45.79
4 x .080 x 7/8-5/8	<b>0408CDUX4-2</b>	\$45.79
4½ x .080 x 20mm	4508BDUX4-2	\$48.24
4½ x .080 x 7/8-5/8	<b>4508CDUX4-2</b>	\$48.24
5 x .080 x 7/8-5/8	<b>0508CDUX4-2</b>	\$55.95
6 x .095 x 7/8-5/8	<b>0609CDUX4-2</b>	\$70.19
6 x .095 x U/A	<b>0609UDUX4-2</b>	\$70.19
7 x .095 x 7/8-5/8	0709CDUX4-2	\$99.63
7 x .095 x U/A	<b>0709UDUX4-2</b>	\$99.63
7 x .125 x 7/8-5/8	<b>0712CDUX4-2</b>	\$130.12

Size	Part #	List Price
8 x .095 x U/A	<b>0809UDUX4-2</b>	\$109.44
9 x .095 x 7/8-5/8	<b>0909CDUX4-2</b>	\$130.47
9 x .095 x U/A	<b>0909UDUX4-2</b>	\$130.47
10 x .095 x 7/8-5/8	<b>1009CDUX4-2</b>	\$150.44
10 x .095 x U/A	<b>1009UDUX4-2</b>	\$150.44
10 x .125 x 1/20mm	<b>1012EDUX4-2</b>	\$187.23
10 x .187 x 1	<b>1018EDUX4-2</b>	\$240.73
10 x .250 x 1	<b>1025EDUX4-2</b>	\$303.92

PART #'S IN BOLD INDICATE ROUTINELY STOCKED PRODUCTS

**X200**  
GENERAL PURPOSE



**HEAVY DUTY GRADE**

- 10mm (.394") turbo rim height
- Narrow with cooling holes

**APPLICATIONS** - Concrete, Roofing Tile, Stone

Size	Part #	List Price
4 x .080 x 7/8-5/8	0408CDZBX2-2	\$53.26
4½ x .080 x 7/8-5/8	4508CDZBX2-2	\$56.73
5 x .080 x 7/8-5/8	0508CDZBX2-2	\$63.66
6 x .095 x 7/8-5/8	0609CDZBX2-2	\$83.39
7 x .095 x DM-5/8	0709DDZBX2-2	\$86.79
7 x .095 x U/A	0709UDZBX2-2	\$86.79
8 x .095 x U/A	0809UDZBX2-2	\$110.03
9 x .095 x DM-5/8	0909DDZBX2-2	\$149.39
10 x .095 x U/A	1009UDZBX2-2	\$176.02

**X100**  
GENERAL PURPOSE



**VALUE GRADE**

- 10mm (.394") turbo rim height
- Turbo Rim with cooling holes

**APPLICATIONS** - Reinforced Concrete, Brick, Block, Concrete Roofing Tile, Clay Roofing Tile, Landscaping Stone

Size	Part #	List Price
4 x .080 x 7/8-5/8	0408CDZBX0-2	\$16.94
4½ x .080 x 7/8-5/8	4508CDZBX0-2	\$21.26
5 x .080 x 7/8-5/8	0508CDZBX0-2	\$22.78
6 x .095 x U/A	0609UDZBX0-2	\$34.93
7 x .095 x DM-5/8	0709DDZBX0-2	\$42.51
7 x .095 x U/A	0709UDZBX0-2	\$42.51
8 x .095 x DM-5/8	0809DDZBX0-2	\$61.55
8 x .095 x U/A	0809UDZBX0-2	\$61.55
9 x .095 x U/A	0909UDZBX0-2	\$79.78
10 x .095 x 7/8-5/8	1009CDZBX0-2	\$82.31
10 x .095 x DM-5/8	1009DDZBX0-2	\$82.31

**Y101 TURBO**  
GENERAL PURPOSE



**QUALITY GRADE**

- 10mm (.394") segment height
- Keyhole slot, turbo segment

**APPLICATIONS** - Reinforced Concrete, Brick, Block, Cured Concrete

Size	Part #	List Price
4 x .080 x 7/8-5/8	0408CZY1-2	\$24.29
4½ x .080 x 7/8-5/8	4508CZY1-2	\$30.37
5 x .080 x 7/8-5/8	0508CZY1-2	\$36.45
6 x .095 x 7/8-5/8	0609CZY1-2	\$48.59
7 x .095 x U/A	0709UZY1-2	\$54.66
10 x .095 x U/A	1009UZY1-2	\$105.82

**Y100**  
GENERAL PURPOSE



◇◇ **QUALITY GRADE**

- 7mm (.276") turbo rim height
- Turbo rim with cooling holes

**APPLICATIONS** - Reinforced Concrete, Brick, Block, Concrete Roofing Tile, Clay Roofing Tile, Landscaping Stone

Size	Part #	List Price
4 x .080 x 7/8-5/8	<b>0408CDZBY1-2</b>	\$15.54
4 1/2 x .080 x 7/8-5/8	<b>4508CDZBY1-2</b>	\$19.50
5 x .080 x 7/8-5/8	<b>0508CDZBY1-2</b>	\$20.79
7 x .095 x U/A	<b>0709UDZBY1-2</b>	\$38.90
10 x .095 x U/A	1009UDZBY1-2	\$75.22

**Y100**  
GENERAL PURPOSE



◇◇ **QUALITY GRADE**

- 10mm (.394") segment height
- Keyhole slot

**APPLICATIONS** - Reinforced Concrete, Brick, Block, Cured Concrete

Size	Part #	List Price
4 x .080 x 20mm	0408BDUY1-2	\$23.12
4 x .080 x 7/8-5/8	<b>0408CDUY1-2</b>	\$23.12
4 1/2 x .080 x 7/8-5/8	<b>4508CDUY1-2</b>	\$28.96
5 x .080 x 7/8-5/8	<b>0508CDUY1-2</b>	\$34.69
6 x .095 x 7/8-5/8	<b>0609CDUY1-2</b>	\$44.03
6 x .095 x U/A	<b>0609UDUY1-2</b>	\$44.03
7 x .095 x 7/8-5/8	<b>0709CDUY1-2</b>	\$52.10
7 x .095 x DM-5/8	<b>0709DDUY1-2</b>	\$52.10

Size	Part #	List Price
7 x .095 x U/A	<b>0709UDUY1-2</b>	\$52.10
8 x .095 x DM-5/8	<b>0809DDUY1-2</b>	\$71.84
8 x .095 x U/A	<b>0809UDUY1-2</b>	\$71.84
9 x .095 x 7/8-5/8	<b>0909CDUY1-2</b>	\$86.79
9 x .095 x U/A	<b>0909UDUY1-2</b>	\$86.79
10 x .095 x 7/8-5/8	<b>1009CDUY1-2</b>	\$100.69
10 x .095 x U/A	<b>1009UDUY1-2</b>	\$100.69

**ES101 TURBO**  
GENERAL PURPOSE



◆ **ECONOMY GRADE**

- 10mm (.394") segment height
- Keyhole slot, turbo segment
- Sintered
- 9" specifically designed for battery powered gas saws

**APPLICATIONS** - Reinforced Concrete, Brick, Block, Cured Concrete

Size	Part #	List Price
4 x .080 x 7/8-5/8	0408CSZ1-2	\$19.07
4 1/2 x .080 x 7/8-5/8	4508CSZ1-2	\$20.45
5 x .080 x 7/8-5/8	0508CSZ1-2	\$21.80
6 x .090 x 7/8-5/8	0609CSZ1-2	\$29.97
7 x .095 x U/A-5/8	0709USZ1-2	\$38.14
9 x .095 x 7/8-5/8	0909CSZ1-2	\$62.65



**ES101**  
GENERAL PURPOSE



◆ **ECONOMY GRADE**

- 10mm (.394") segment height
- Keyhole slot
- Sintered

**APPLICATIONS** - Reinforced Concrete, Brick, Block, Cured Concrete

Size	Part #	List Price
4 x .060 x 7/8-5/8	<b>0406CSIT</b>	\$15.18
4 1/2 x .060 x 7/8-5/8	<b>4506CSIT</b>	\$19.74
5 x .060 x 7/8-5/8	<b>0506CSIT</b>	\$24.99
7 x .080 x U/A	<b>0708USIT</b>	\$40.88
8 x .095 x U/A	<b>0809USIT</b>	\$49.06
9 x .095 x U/A	<b>0909USIT</b>	\$75.49
10 x .095 x U/A	<b>1009USIT</b>	\$85.62

**X400**  
SEGMENTED ABRASIVES



◆◆◆ **SUPREME GRADE**

- 10mm (.394") segment height
- Keyhole slot

**APPLICATIONS** - Asphalt, Green Concrete

Size	Part #	List Price
4 x .080 x 7/8-5/8	0408CDUX4-4	\$44.97
5 x .095 x 7/8-5/8	0508CDUX4-4	\$54.43
6 x .095 x U/A	<b>0609UDUX4-4</b>	\$68.80
7 x .095 x U/A	<b>0709UDUX4-4</b>	\$99.04
8 x .095 x 7/8-5/8	<b>0809CDUX4-4</b>	\$112.13
8 x .095 x U/A	<b>0809UDUX4-4</b>	\$112.13

Size	Part #	List Price
8 x .125 x 1/20mm	0812EDUX4-4	\$151.96
9 x .095 x 7/8-5/8	<b>0909CDUX4-4</b>	\$127.90
10 x .095 x 7/8-5/8	1009CDUX4-4	\$147.06
10 x .095 x DM-5/8	<b>1009DDUX4-4</b>	\$147.06
10 x .095 x U/A	1009UDUX4-4	\$147.06
10 x .125 x 1/20mm	1012EDUX4-4	\$206.63

**X200-AC**  
METAL CUTTING



◆◆◆ **HEAVY DUTY GRADE**

- 5mm (.196") segment height
- Brazed segment, with cooling hole

**APPLICATIONS** - PVC Pipe, Steel, Cast Iron, Ductile Iron Pipe, Reinforced Concrete

Size	Part #	List Price
3 x .090 x 3/8	0309TDUX2-AC2	\$52.45
4 x .110 x 7/8-5/8	0411CDUX2-AC2	\$63.89
4.5 x .110 x 7/8-5/8	4511CDUX2-AC2	\$67.75
5 x .110 x 7/8-5/8	0511CDUX2-AC2	\$76.27
6 x .125 x U/A	0612UDUX2-AC2	\$104.88
7 x .125 x U/A	<b>0712UDUX2-AC2</b>	\$120.42
8 x .125 x U/A	<b>0812UDUX2-AC2</b>	\$162.12
9 x .125 x U/A	0912UDUX2-AC2	\$185.95
10 x .125 x U/A	<b>1012UDUX2-AC2</b>	\$219.35

# TUCK POINT & CRACK CHASER

## TUCK POINT PERFORMANCE CHART



### X201 TUCK POINT



#### HEAVY DUTY GRADE

- 13.5mm (.531") segment height
- Punch hole core

APPLICATIONS - Mortar, Concrete

Size	Part #	List Price
4 x .250 x 1/8-5/8	0425CDPX2-1T	\$70.63
4 1/2 x .250 x 1/8-5/8	4525CDPX2-1T	\$83.36
5 x .250 x 1/8-5/8	0525CDPX2-1T	\$96.11

PART #'S IN BOLD INDICATE ROUTINELY STOCKED PRODUCTS

**X200**  
TUCK POINT



**HEAVY DUTY GRADE**

- 10mm (.394") segment height

**APPLICATIONS** - Mortar, Concrete

Size	Part #	List Price
3 x .250 x 7/8-5/8	0325CDPX2-1	\$57.94
4 x .250 x 7/8-5/8	<b>0425CDPX2-1</b>	\$74.05
4 x .500 x 7/8-5/8	<b>0450CDPX2-1</b>	\$162.12
4 1/2 x .250 x 7/8-5/8	<b>4525CDPX2-1</b>	\$79.89
5 x .250 x 7/8-5/8	<b>0525CDPX2-1</b>	\$92.63
6 x .250 x 7/8-5/8	<b>0625CDPX2-1</b>	\$115.75
7 x .250 x 7/8-5/8	<b>0725CDPX2-1</b>	\$157.44

**X100**  
TUCK POINT



**VALUE GRADE**

- 10mm (.394") segment height

**APPLICATIONS** - Mortar, Concrete

Size	Part #	List Price
4 x .250 x 7/8-5/8	<b>0425CDPX1-1T</b>	\$48.59
4 1/2 x .250 x 7/8-5/8	<b>4525CDPX1-1T</b>	\$57.94
5 x .250 x 7/8-5/8	<b>0525CDPX1-1T</b>	\$73.01

**ES110**  
TUCK POINT



**ECONOMY GRADE**

- 10mm (.394") segment height
- Punch hole core
- Laser welded

**APPLICATIONS** - Mortar, Concrete

Size	Part #	List Price
4 x .250 x 7/8-5/8	0425CDPX0-1T	\$57.89
4 1/2 x .250 x 7/8-5/8	<b>4525CDPX0-1T</b>	\$69.47
5 x .250 x 7/8-5/8	<b>0525CDPX0-1T</b>	\$81.05
7 x .250 x 7/8-5/8	0725CDPX0-1T	\$127.36



**ES100**  
TUCK POINT



◆ **ECONOMY GRADE**

- 10mm (.394") segment height
- Sintered

**APPLICATIONS** - Mortar, Concrete

Size	Part #	List Price
4 x .250 x 7/8-5/8	<b>0425CDPX0-1</b>	\$42.87
4 1/2 x .250 x 7/8-5/8	<b>4525CDPX0-1</b>	\$47.42
5 x .250 x 7/8-5/8	<b>0525CDPX0-1</b>	\$59.10
7 x .250 x 7/8-5/8	<b>0725CDPX0-1</b>	\$108.86

**X200**  
DOUBLE TUCK POINT



◆◆ **HEAVY DUTY GRADE**

- 10mm (.394") segment height
- Laser welded blade
- Sandwich double blade

**APPLICATIONS** - Mortar, Concrete

Size	Part #	List Price
4 x .250 x 7/8-5/8	<b>0408CDBX2</b>	\$91.34
4 1/2 x .250 x 7/8-5/8	<b>4508CDBX2</b>	\$95.43
5 x .250 x 7/8-5/8	<b>0508CDBX2</b>	\$116.22
7 x .250 x 7/8-5/8	0709CDBX2	\$207.44

**ES100**  
DOUBLE TUCK POINT



◆ **ECONOMY GRADE**

- 10mm (.394") segment height
- Sintered
- Sandwich double blade

**APPLICATIONS** - Mortar, Concrete

Size	Part #	List Price
4 x .250 x 7/8-5/8	0408CDBX1	\$61.33
4 1/2 x .250 x 7/8-5/8	<b>4508CDBX1</b>	\$64.83
5 x .250 x 7/8-5/8	<b>0508CDBX1</b>	\$72.88

**X100**  
TRIPLE TUCK POINT



◆◆◆ VALUE GRADE

- 10mm (.394") segment height
- Sintered
- Sandwich triple blade

APPLICATIONS - Mortar, Concrete

Size	Part #	List Price
4 x .375 x 7/8-5/8	0437CTBX1	\$115.75
4 1/2 x .375 x 7/8-5/8	4537CTBX1	\$138.99
5 x .375 x 7/8-5/8	0537CTBX1	\$162.12
7 x .375 x 7/8-5/8	0737CTBX1	\$277.88

**X300**  
CRACK CHASER



◆◆◆ PREMIUM GRADE

- 12.7mm (.500") segment height
- V-shape segments

APPLICATIONS - Concrete, Asphalt

Size	Part #	List Price
4 x .375 x 7/8-5/8	<b>0401CCV</b>	\$158.74
4 x .375 x 5/8-11	<b>0402CCV</b>	\$158.74
4 x .375 x 5/8-11, w/nut	<b>0404CCV</b>	\$158.74
4 x .500 x 7/8-5/8	<b>0450CCV</b>	\$190.85
4 x .500 x 5/8-11 w/nut	0454CCV	\$190.85
4 1/2 x .375 x 7/8-5/8	<b>4501CCV</b>	\$186.77
4 1/2 x .375 x 5/8-11	<b>4504CCV</b>	\$186.77
5 x .375 x 7/8-5/8	<b>0501CCV</b>	\$197.16

Size	Part #	List Price
5 x .500 x 7/8-5/8	0550CCV	\$283.25
7 x .375 x 7/8-5/8	<b>0701CCV</b>	\$313.27
7 x .375 x 5/8-11, w/nut	<b>0704CCV</b>	\$313.27
7 x .500 x 7/8-5/8	0750CCV	\$376.57
8 x .375 x 7/8-5/8	0801CCV	\$357.88
8 x .375 x 1	<b>0802CCV</b>	\$357.88
8 x .500 x 7/8-5/8	0850CCV	\$426.33
8 x .500 x 1	<b>0850ECCV</b>	\$426.33

# GRINDING & SURFACE PREPARATION

## S-CUP WHEEL CONCRETE



### SUPREME GRADE

- 10mm (.394") segment height
- 16/18 grit, 30/40 grit, 60/80 grit, 120/150 grit available
- Achieve very aggressive grinding, and fast stock removal
- Leaves a uniform finish without swirl marks
- Great for the first steps in polishing
- Holes help with dust extraction
- 5/8" threaded or 7/8" non-threaded
- L=13.5mm HUB, LL=17mm HUB, hub height

APPLICATIONS - Concrete

Size	Grit	Part #	List Price
5 x 7/8	120/140	05CSZX3-120140	\$147.17
5 x 5/8-11	120/140	05HSZX3-120140L	\$174.25
5 x 7/8	16/18	05CSZX3-1618	\$147.17
5 x 5/8-11	16/18	05HSZX3-1618L	\$174.25
5 x 7/8	30/40	05CSZX3-3040	\$147.17
5 x 5/8-11	30/40	05HSZX3-3040L	\$174.25
5 x 7/8	60/80	05CSZX3-6080	\$147.17
5 x 5/8-11	60/80	05HSZX3-6080L	\$174.25

Size	Grit	Part #	List Price
7 x 7/8	120/140	07CSZX3-120140	\$237.70
7 x 5/8-11	120/140	07HSZX3-120140LL	\$271.37
7 x 7/8	16/18	07CSZX3-1618	\$237.70
7 x 5/8-11	16/18	07HSZX3-1618LL	\$271.37
7 x 7/8	30/40	07CSZX3-3040	\$237.70
7 x 5/8-11	30/40	07HSZX3-3040LL	\$271.37
7 x 7/8	60/80	07CSZX3-6080	\$237.70
7 x 5/8-11	60/80	07HSZX3-6080LL	\$271.37

## T-SEG CUP WHEEL CONCRETE



### PREMIUM GRADE

- 5mm (.196") segment height
- T-seg design for fast/aggressive grinding

APPLICATIONS - Concrete, Masonry, Stone

Size	Part #	List Price
4 x 7/8-5/8	04CDTC	\$149.90
4 x 5/8-11	<b>04HDTC</b>	\$149.90
4 1/2 x 7/8-5/8	45CDTC	\$169.99
4 1/2 x 5/8-11	<b>45HDTC</b>	\$169.99
5 x 7/8-5/8	<b>05CDTC</b>	\$189.96
5 x 5/8-11	<b>05HDTC</b>	\$189.96
7 x 7/8-5/8	07CDTC	\$230.00
7 x 5/8-11	<b>07HDTC</b>	\$230.00



## ARROW SEG CUP WHEEL

CONCRETE



### PREMIUM GRADE

- 7mm (.275") segment height
- Arrow segment

APPLICATIONS - Concrete, Masonry, Stone

Size	Part #	List Price
7 x 7/8-5/8	<b>07CARX3</b>	\$249.97
7 x 5/8-11	<b>07HARX3</b>	\$249.97

## X100 SINGLE ROW

CONCRETE & MASONRY

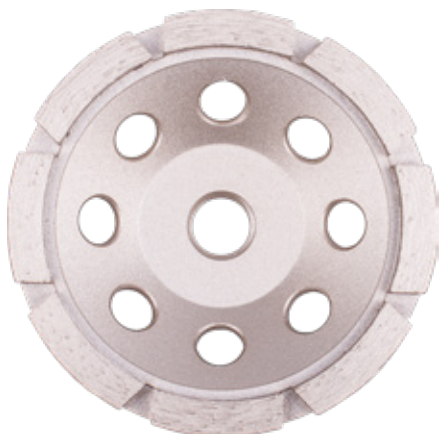

### VALUE GRADE

- 5mm (.196") segment height
- Single row for faster/more aggressive grinding of concrete & masonry applications
- Cup wheel in photo is 4" (04CDDSX1)

APPLICATIONS - Concrete, Masonry

Size	Segs	Part #	List Price
4 x 7/8-5/8	8	<b>04CDDSX1</b>	\$68.95
4 x 5/8-11	8	<b>04HDDSX1</b>	\$68.95
4 1/2 x 7/8-5/8	8	<b>45CDDSX1</b>	\$65.77
4 1/2 x 5/8-11	8	<b>45HDDSX1</b>	\$65.77
5 x 7/8-5/8	10	<b>05CDDSX1</b>	\$75.45
5 x 5/8-11	10	<b>05HDDSX1</b>	\$75.45
7 x 7/8-5/8	12	<b>07CDDSX1</b>	\$118.06
7 x 5/8-11	12	<b>07HDDSX1</b>	\$118.06

## X100 DOUBLE ROW

CONCRETE & MASONRY



### VALUE GRADE

- 5mm (.196") segment height
- Double row for smoothest grinding of concrete & masonry applications
- Cup wheel in photo is 4" (04CDDDX1)

APPLICATIONS - Concrete, Masonry

Size	Segs	Part #	List Price
4 x 7/8-5/8	16	<b>04CDDDX1</b>	\$107.16
4 x 5/8-11	16	<b>04HDDDX1</b>	\$107.16
4 1/2 x 7/8-5/8	16	<b>45CDDDX1</b>	\$123.57
4 1/2 x 5/8-11	16	<b>45HDDDX1</b>	\$123.57
5 x 7/8-5/8	20	<b>05CDDDX1</b>	\$127.98
5 x 5/8-11	20	<b>05HDDDX1</b>	\$127.98
7 x 7/8-5/8	24	<b>07CDDDX1</b>	\$181.51
7 x 5/8-11	24	<b>07HDDDX1</b>	\$181.51

**X100 SINGLE TURBO**

CONCRETE &amp; MASONRY



## ◆◆◆ VALUE GRADE

- 5mm (.196") segment height
- Single turbo style for faster/more aggressive grinding of concrete & masonry applications
- Cup wheel in photo is 4" (04CDDGSX1)

APPLICATIONS - Concrete, Masonry

Size	Segs	Part #	List Price
4 x 7/8-5/8	8	<b>04CDDGSX1</b>	\$51.19
4 x 5/8-11	8	<b>04HDDGSX1</b>	\$51.19
4 1/2 x 7/8-5/8	9	<b>45CDDGSX1</b>	\$55.72
4 1/2 x 5/8-11	9	<b>45HDDGSX1</b>	\$55.72
5 x 7/8-5/8	9	<b>05CDDGSX1</b>	\$62.48
5 x 5/8-11	9	<b>05HDDGSX1</b>	\$62.48
7 x 7/8-5/8	12	<b>07CDDGSX1</b>	\$95.17
7 x 5/8-11	12	<b>07HDDGSX1</b>	\$95.17

**X100 DOUBLE TURBO**

CONCRETE &amp; MASONRY



## ◆◆◆ VALUE GRADE

- 5mm (.196") segment height
- Double turbo style for smoothest grinding of concrete & masonry applications
- Cup wheel in photo is 4" (04CDDGDX1)

APPLICATIONS - Concrete, Masonry, Stone

Size	Segs	Part #	List Price
4 x 7/8-5/8	14	<b>04CDDGDX1</b>	\$73.36
4 x 5/8-11	14	<b>04HDDGDX1</b>	\$73.36
4 1/2 x 7/8-5/8	18	<b>45CDDGDX1</b>	\$91.98
4 1/2 x 5/8-11	18	<b>45HDDGDX1</b>	\$91.98
5 x 7/8-5/8	18	<b>05CDDGDX1</b>	\$98.95
7 x 7/8-5/8	24	<b>07CDDGDX1</b>	\$134.59
7 x 5/8-11	24	<b>07HDDGDX1</b>	\$134.59
7 x 5/8-11, 1/2" HUB	24	<b>07HDDGDX1L</b>	\$151.15

**X100 TURBO FAN**

CONCRETE &amp; MASONRY



## ◆◆◆ VALUE GRADE

- 5mm (.196") segment height
- Wing tipped segments
- L shape turbo fan design to help disperse materials being ground

APPLICATIONS - Concrete, Masonry, Stone

Size	Part #	List Price
4 x 7/8-5/8	04CDFCX1-1	\$154.93
4 x 5/8-11	04HDFCX1-1	\$154.93
4 1/2 x 5/8-11	45HDFCX1-1	\$175.01
5 x 5/8-11	05HDFCX1-1	\$189.96
7 x 7/8-5/8	07CDFCX1-1	\$269.93
7 x 5/8-11	07HDFCX1-1	\$269.93

## X0 SINGLE ROW

CONCRETE & MASONRY



### ◇◇ QUALITY GRADE

- 5mm (.196") segment height
- Single row for faster/more aggressive grinding of concrete & masonry applications

**APPLICATIONS** - Concrete, Masonry

Size	Part #	List Price
4 x 7/8-5/8	04CDDSX0	\$46.66
4 x 5/8-11	04HDDSX0	\$46.66
4 1/2 x 7/8-5/8	45CDDSX0	\$53.40
4 1/2 x 5/8-11	45HDDSX0	\$53.40
5 x 7/8-5/8	05CDDSX0	\$59.04
5 x 5/8-11	05HDDSX0	\$59.04
7 x 7/8-5/8	07CDDSX0	\$87.44
7 x 5/8-11	07HDDSX0	\$87.44

## X0 DOUBLE ROW

CONCRETE & MASONRY

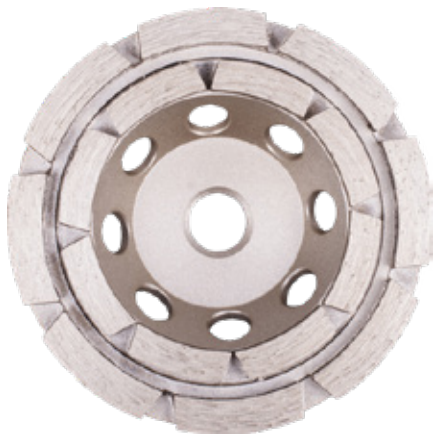

### ◇◇ QUALITY GRADE

- 5mm (.196") segment height
- Double row for smoothest grinding of concrete & masonry applications

**APPLICATIONS** - Concrete, Masonry

Size	Part #	List Price
4 x 7/8-5/8	04CDDDX0	\$80.58
4 x 5/8-11	04HDDDX0	\$80.58
4 1/2 x 7/8-5/8	45CDDDX0	\$88.67
4 1/2 x 5/8-11	45HDDDX0	\$88.67
7 x 7/8-5/8	07CDDDX0	\$134.59
7 x 5/8-11	07HDDDX0	\$134.59

## GRINDING BLOCKS

CONCRETE



### ◆◆ PREMIUM GRADE

- For grinding of concrete floors
- Designed to fit the industry's most popular machines

**APPLICATIONS** - Concrete

Size	Part #	List Price
2 x 2 x 4 (Med Bond)	<b>GB224-2</b>	\$365.57
2 x 2 x 4 (Hard Bond)	GB224-3	\$386.14



**X100 PCD CUP WHEEL**

EPOXY REMOVAL



## ◆◆◆ VALUE GRADE

- 2 plain dummy segment
- Small PCDs

APPLICATIONS - Epoxy, Paint Removal

Size	Part #	List Price
4 x 7/8-5/8	04CPCD2	\$294.23
4 x 5/8-11	04HPCD2	\$294.23
4 1/2 x 7/8-5/8	45CPCD2	\$334.93
4 1/2 x 5/8-11	<b>45HPCD2</b>	\$334.93
5 x 7/8-5/8	05CPCD2	\$377.02
5 x 5/8-11	<b>05HPCD2</b>	\$377.02
6 x 7/8-5/8	06CPCD2	\$425.60
6 x 5/8-11	06HPCD2	\$425.60
7 x 7/8-5/8	07CPCD2	\$460.90
7 x 5/8-11	<b>07HPCD2</b>	\$460.90

**X200 PCD CUP WHEEL**

EPOXY REMOVAL



## ◆◆ HEAVY DUTY GRADE

- Small PCDs

APPLICATIONS - Epoxy, Paint Removal

Size	Part #	List Price
4 x 5/8-11	04HPCD3	\$388.80
4 1/2 x 5/8-11	<b>45HPCD3</b>	\$436.41
5 x 5/8-11	05HPCD3	\$462.85
7 x 5/8-11	<b>07HPCD3</b>	\$573.94

**X300 PCD CUP WHEEL**

EPOXY REMOVAL



## ◆◆◆ PREMIUM GRADE

- Large PCDs

APPLICATIONS - Epoxy, Paint Removal

Size	Part #	List Price
4 x 7/8-5/8	04CPCD2P	\$383.92
4 x 5/8-11	04HPCD2P	\$383.92
4 1/2 x 7/8-5/8	45CPCD2P	\$405.90
4 1/2 x 5/8-11	45HPCD2P	\$405.90
5 x 7/8-5/8	05CPCD2P	\$494.89
5 x 5/8-11	05HPCD2P	\$494.89
6 x 7/8-5/8	06CPCD2P	\$599.86
6 x 5/8-11	06HPCD2P	\$599.86
7 x 7/8-5/8	07CPCD2P	\$735.84
7 x 5/8-11	07HPCD2P	\$735.84

PART #'S IN BOLD INDICATE ROUTINELY STOCKED PRODUCTS

**GRINDING HEAD • TURBO**

CONCRETE

**PREMIUM GRADE**

- 20 seg
- For grinding of concrete floors
- Equipped with special bolt hole pattern to fit industry's most popular machines

**APPLICATIONS** - Concrete, Masonry, Asphalt

Size	Segs	Bond	Part #	List Price
10 x 5/8"	20 turbo segs	Medium	<b>DVCCM2009</b>	\$572.22

**GRINDING HEAD • 10 SEG**

CONCRETE

**PREMIUM GRADE**

- 5mm (.196") segment height
- For grinding of concrete floors
- Equipped with special bolt hole pattern to fit industry's most popular machines

**APPLICATIONS** - Concrete, Masonry, Asphalt

Size	Segs	Bond	Part #	List Price
10 x 5/8"	10	Medium	<b>DVCCM1001</b>	\$333.51
10 x 5/8"	10	Hard	DVCCM1002	\$333.51

**GRINDING HEAD • 20 SEG**

CONCRETE

**PREMIUM GRADE**

- 5mm (.196") segment height
- For grinding of concrete floors
- Equipped with special bolt hole pattern to fit industry's most popular machines

**APPLICATIONS** - Concrete, Masonry, Asphalt

Size	Segs	Bond	Part #	List Price
10 x 5/8"	20	Medium	<b>DVCCM2001</b>	\$476.79
10 x 5/8"	20	Hard	<b>DVCCM2002</b>	\$476.79

## HYBRID METALLIC PADS

CONCRETE



- Utilizes a hybrid bond of metal and resin to remove any remaining scratches and prepare the floor for final polishing
- Available in 30-400 grit sizes

**APPLICATIONS** - Concrete

Grit Size	Part #	Diameter	List Price
Grit 30	<b>3MPPD-30</b>	3"	\$38.54
Grit 50	<b>3MPPD-50</b>	3"	\$38.54
Grit 100	<b>3MPPD-100</b>	3"	\$47.13
Grit 200	<b>3MPPD-200</b>	3"	\$47.13
Grit 400	<b>3MPPD-400</b>	3"	\$47.13

## RESIN PADS

CONCRETE



- Used as a final polish, the resin bonded pads are specially designed for a slow wear rate, ensuring long pad life
- Available in 50-3000 grit sizes.

**APPLICATIONS** - Concrete

Grit Size	Part #	Diameter	List Price
Grit 50	<b>3PPPD-50</b>	3"	\$33.46
Grit 100	<b>3PPPD-100</b>	3"	\$38.54
Grit 200	<b>3PPPD-200</b>	3"	\$38.54
Grit 400	<b>3PPPD-400</b>	3"	\$38.54
Grit 800	<b>3PPPD-800</b>	3"	\$38.95
Grit 1500	<b>3PPPD-1500</b>	3"	\$38.95
Grit 3000	<b>3PPPD-3000</b>	3"	\$38.95

## DRY WHITE RESIN PADS

CONCRETE



- Used as a final polish, the resin bonded pads are specially designed for a slow wear rate, ensuring long pad life
- Available in 50-3000 grit sizes.

**APPLICATIONS** - Concrete

Grit Size	Part #	Diameter	List Price
Grit 50	<b>3WPPD-50</b>	3"	\$55.31
Grit 100	<b>3WPPD-100</b>	3"	\$55.31
Grit 200	<b>3WPPD-200</b>	3"	\$55.31
Grit 400	<b>3WPPD-400</b>	3"	\$55.31
Grit 800	<b>3WPPD-800</b>	3"	\$55.31
Grit 1500	<b>3WPPD-1500</b>	3"	\$55.31
Grit 3000	<b>3WPPD-3000</b>	3"	\$55.31



**DUAL-PURPOSE RESIN PADS**  
CONCRETE

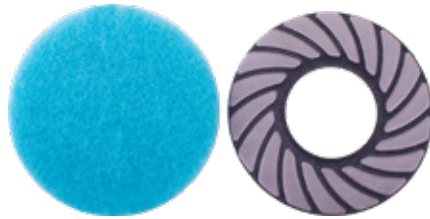

Velcro® pad sold separately

- Velcro® with interchangeable pads with varying diamond grit for grinding and polishing of concrete, cement overlays, and stone floors. We offer seven different grit sizes, from 50 to 3000. Once you finish with one grit size, simply pull off and put on the next pad. This eliminates the need to change the entire pad every time.

**APPLICATIONS - Concrete**

Grit Size	Part #	Diameter	List Price
50	07DPPPWD-50	7"	\$109.79
100	07DPPPWD-100	7"	\$109.79
200	07DPPPWD-200	7"	\$109.79
400	07DPPPWD-400	7"	\$109.79
800	07DPPPWD-800	7"	\$109.79
1500	07DPPPWD-1500	7"	\$109.79
3000	07DPPPWD-3000	7"	\$109.79
	VELCROPAD07	7"	\$6.24
50	09DPPPWD-50	9"	\$131.99
100	09DPPPWD-100	9"	\$131.99
200	09DPPPWD-200	9"	\$131.99
400	09DPPPWD-400	9"	\$131.99

Grit Size	Part #	Diameter	List Price
800	09DPPPWD-800	9"	\$131.99
1500	09DPPPWD-1500	9"	\$131.99
3000	09DPPPWD-3000	9"	\$131.99
	VELCROPAD09	9"	\$9.32
50	11DPPPWD-50	11"	\$150.67
100	11DPPPWD-100	11"	\$150.67
200	11DPPPWD-200	11"	\$150.67
400	11DPPPWD-400	11"	\$150.67
800	11DPPPWD-800	11"	\$150.67
1500	11DPPPWD-1500	11"	\$150.67
3000	11DPPPWD-3000	11"	\$150.67
	VELCROPAD11	11"	\$12.47

**BURNISHING PADS**  
CONCRETE



- Diamond coated pads for cleaning and polishing a wide range materials such as Natural stone, Engineered stone, Terrazzo, Polished concrete. These pads will help keep your floor clean and shiny, reducing long-term maintenance costs.

**APPLICATIONS - Natural Stone, Engineered Stone, Terrazzo, Concrete**

Grit Size	Part #	Diameter	List Price
400	17BPPWD-400	17"	\$86.07
800	17BPPWD-800	17"	\$86.07
1500	17BPPWD-1500	17"	\$86.07
3000	17BPPWD-3000	17"	\$86.07
400	20BPPWD-400	20"	\$104.35
800	20BPPWD-800	20"	\$104.35
1500	20BPPWD-1500	20"	\$104.35
3000	20BPPWD-3000	20"	\$104.35
400	21BPPWD-400	21"	\$116.04
800	21BPPWD-800	21"	\$116.04

Grit Size	Part #	Diameter	List Price
1500	21BPPWD-1500	21"	\$116.04
3000	21BPPWD-3000	21"	\$116.04
400	24BPPWD-400	24"	\$140.16
800	24BPPWD-800	24"	\$140.16
1500	24BPPWD-1500	24"	\$140.16
3000	24BPPWD-3000	24"	\$140.16
400	27BPPWD-400	27"	\$159.67
800	27BPPWD-800	27"	\$159.67
1500	27BPPWD-1500	27"	\$159.67
3000	27BPPWD-3000	27"	\$159.67

**FAST EDGE CERAMIC CUP WHEELS**  
CONCRETE



- Fast Edge is a revolutionary design that improves the quality of edge work while reducing the scratches and gouging that metal bond cup wheels can cause. The Fast Edge system will eliminate metal bond cup wheels on most concrete polishing projects. Fast Edge is fast, light weight and easy to use resulting in a superior edge.
- Fast Edge Ceramic Cup wheels can run on most hand grinders and walk behind edge machines that use a 5" or 7" wheel with 5/8"-11 threaded connection. Please review maximum operating speed marked on our wheel and compare it to your grinder's rpm. Do not exceed the maximum operating speed of the wheel.

**APPLICATIONS - Concrete**

Size	Grit	Part #	List Price
5 x 5/8-11	30	FG-05HCW-30	\$135.22
5 x 5/8-11	50	FG-05HCW-50	\$135.22
5 x 5/8-11	100	FG-05HCW-100	\$135.22
5 x 5/8-11	200	FG-05HCW-200	\$135.22
5 x 5/8-11	400	FG-05HCW-400	\$135.22
7 x 5/8-11	30	FG-07HCW-30	\$181.45
7 x 5/8-11	50	FG-07HCW-50	\$181.45
7 x 5/8-11	100	FG-07HCW-100	\$181.45
7 x 5/8-11	200	FG-07HCW-200	\$181.45
7 x 5/8-11	400	FG-07HCW-400	\$181.45

**RESIN WING PADS**

CONCRETE POLISHING



- Velcro® for easy attachment /detachment, no tools required.
- 30 grit to 3000 grit
- Simple to use and light weight
- Great for smaller jobs or tight places where larger machines are not practical
- Basements, second stories or anywhere you can't get a large machine
- Get professional results with a lighter machine
- Great for beginners or rental companies
- Large heavy concrete polishing machines can achieve an 80° reading on a gloss meter. Wing pads can achieve this same level of shine.
- Designed for use with 17" floor sanders. 18" backer pads available.

**APPLICATIONS** - Concrete, Masonry, Stone

Grit	Part #	Buffer Size	List Price
50	<b>WPR-50</b>	17"	\$21.43
100	<b>WPR-100</b>	17"	\$21.43
200	<b>WPR-200</b>	17"	\$21.43
400	<b>WPR-400</b>	17"	\$21.43
800	<b>WPR-800</b>	17"	\$21.43
1500	<b>WPR-1500</b>	17"	\$21.43
3000	WPR-3000	17"	\$21.43

Size	Part #	List Price
18" Pad Driver for Wing Pad (for 17" machine)	WP-DPLATE	*call for pricing

**METAL WING PADS**

CONCRETE POLISHING



- Velcro® for easy attachment /detachment, no tools required
- 30 grit to 3000 grit
- Simple to use and light weight
- Great for smaller jobs or tight places where larger machines are not practical
- Basements, second stories or anywhere you can't get a large machine
- Get professional results with a lighter machine
- Great for beginners or rental companies
- Large heavy concrete polishing machines can achieve an 80° reading on a gloss meter. Wing pads can achieve this same level of shine.
- Designed for use with 17" floor sanders. 18" backer pads available.

**APPLICATIONS** - Concrete, Masonry, Stone

Grit	Part #	Buffer Size	List Price
25	<b>WPM-25</b>	17"	\$62.68
30	<b>WPM-30</b>	17"	\$42.87
60	<b>WPM-60</b>	17"	\$42.87
100	<b>WPM-100</b>	17"	\$42.87

Size	Part #	List Price
18" Pad Driver for Wing Pad (for 17" machine)	WP-DPLATE	*call for pricing

**DUST SHROUD**

DUST COLLECTION



- Suitable for major brands
- Made by high quality PVC and Nylon to ensure long operation and light weight
- Designed for easy install and use
- Brush rings to keep dust away
- This shroud does not fit grinding cup wheels with a height greater than 34.8mm (1.37")

**APPLICATIONS** - Dust Collection

Size	Part #	List Price
5" Sliding Type with Brush	05DSHROUD	\$137.67
7" Sliding Type with Brush	07DSHROUD	\$156.82

## F.A.S.T. SYSTEM

Not just another concrete polishing system, our proprietary F.A.S.T. (Flexible Angle Segment Technology) system makes changing segments fast and easy. It's the only system with user selectable segment angle with each segment angle producing different grinding speed and surface finish. The user can select the best segment angle for the job at hand.



### SEGMENT CONFIGURATIONS



**Horizontal**  
 Aggressiveness: ●●●●●  
 Scratch Pattern: rough scratch pattern Ideal for grinding down or surface re-coating



**Slant**  
 Aggressiveness: ●●●●○  
 Scratch Pattern: shallow, smooth scratch pattern Ideal for preparing floor for polishing/finishing



**Combination: Vertical & Slant**  
 Aggressiveness: ●●●●○  
 Scratch Pattern: shallowest & smoothest scratch pattern delivers best surface finish while maintaining aggressive grinding speed



**Vertical**  
 Aggressiveness: ●○○○○  
 Scratch Pattern: shallowest & smoothest scratch pattern Ideal for showroom and other high-end applications

### AGGRESSIVENESS SCALE

- Most aggressive grinding
- Aggressive grinding
- Best transitional grinding
- Least aggressive grinding

SEGMENT	METAL SEGMENT				List Price	PCD SEGMENT
	CONCRETE					Adhesive, Epoxy, Urethane, Paint Removal
APPLICATION	VERY HARD	HARD	MEDIUM HARD	SOFT		
16/18	FGPDV-1618-05-CHC	FGPDV-1618-1-HC	FGPDV-1618-2-MC	FGPDV-1618-4-SC	\$57.83	FGPDV-PCD1 \$118.33
30/40	FGPDV-3040-05-CHC	FGPDV-3040-1-HC	FGPDV-3040-2-MC	FGPDV-3040-4-SC	\$57.83	
60/80	FGPDV-6080-05-CHC	FGPDV-6080-1-HC	FGPDV-6080-2-MC	FGPDV-6080-4-SC	\$57.83	FGPDV-PCD2 \$134.21
120/150	FGPDV-120150-05-CHC	FGPDV-120150-1-HC	FGPDV-120150-2-MC	HS40aP120150ARQC	\$57.83	





**TILE PRODUCTS PERFORMANCE CHART**



**ZENESIS™ NANO**  
DRY PORCELAIN TILE



**ZENESIS™ GRADE**

- 10mm (.394") segment height
- Mesh-style turbo rim blades are quickly becoming the most popular blade in the stone and tile industry
- Our team of engineers was tasked to create a fast and clean cutting blade to cover the entire spectrum of porcelain tiles
- Our new ZENESIS™ Nano Dry Porcelain Blade was 40% faster than the leading competitor with significantly cleaner cuts\*. When other tile blades stop cutting and glaze over this blade keeps cutting effortlessly from start to finish.
- Ultra Thin Mesh rim
- **Do not use for radius cutting**

**APPLICATIONS** - Porcelain Tile, Ceramic Tile, Porcelain Pavers

Size	Part #
4 x .050 x 7/8-5/8, Hub	0406C4PDX4Z
4 1/2 x .050 x 7/8-5/8, Hub	4506C4PDX4Z
5 x .050 x 7/8-5/8, Hub	0506C4PDX4Z
6 x .063 x 7/8-5/8, Hub	0606C4PDX4Z
7 x .063 x U/A-7/8-5/8, Hub	0706U4PDX4Z
10 x .063 x 5/8, Hub	1006A4PDX4Z
14 x .110 x 1, No Hub	1411E4PDX4Z

CALL FOR PRICING

PART #'S IN BOLD INDICATE ROUTINELY STOCKED PRODUCTS

\*BASED ON INTERNAL TESTING



**ZENESIS™ NANO**  
GLASS COATED PORCELAIN TILE



**ZENESIS™ GRADE**

- 10mm(.394") segment height
- The ZENESIS™ Nano is the first hybrid tile blade designed to cut chip-free on next-generation coated porcelains. A high concentration of the highest quality diamonds combined with our special metal bond matrix gives the speed of a high-quality porcelain blade and the finish of a premium glass blade. We have also added extra reinforcement to the core to keep the blade running true and straight when cutting large format tiles.

**APPLICATIONS** - Glass Coated Porcelain, Porcelain Tile, Porcelain Pavers

CALL FOR PRICING

Size	Part #
7 x .060 x 5/8"	<b>S-0706AWNZ</b>
10 x .060 x 5/8"	<b>S-1006AWNZ</b>

**ZENESIS™**  
HARD MATERIALS



**ZENESIS™ GRADE**

- 4"-6": 6.5mm (.255") segment height
- 7"-14": 10mm(.394") segment height
- Unique slot and rim design give the ZENESIS™ Continuous Rim Blade unparalleled cutting precision and performance, all without breaking a sweat. And since the blade incorporates ZENESIS™ pattern technology, fabricators can count on exceptionally smooth, chip-free cutting of porcelain tile, granite and other hard materials.
- Use 4", 4.5", 5" and 6" wet and dry, All other sizes must be used wet
- **Do not use for radius cutting**

**APPLICATIONS** - Pool Tile, Large Format Porcelain, Porcelain Pavers, Stone

CALL FOR PRICING

Size	Part #
4 x .063 x 7/8"-20mm-5/8"	<b>S-0406CTZ</b>
4 1/2 x .063 x 7/8"-20mm-5/8"	<b>S-4506CTZ</b>
5 x .063 x 7/8"-20mm-5/8"	<b>S-0506CTZ</b>
6 x .063 x 7/8"-20mm-5/8"	<b>S-0606CTZ</b>
7 x .063 x U/A(DM-5/8")	<b>S-0706UTZ</b>
8 x .063 x 1-5/8"	<b>S-0806ETZ</b>

Size	Part #
8 x .063 x U/A(DM-5/8")	<b>S-0806UTZ</b>
10 x .080 x 1-5/8"	<b>S-1008ETZ</b>
12 x .080 x 1-5/8"	<b>S-1208ETZ</b>
12 x .080 x 60-50mm	<b>S-1208TTZ</b>
14 x .080 x 1-5/8"	<b>S-1408ETZ</b>
14 x .080 x 60-50mm	<b>S-1408TTZ</b>

**ZENESIS™ PORCELAIN**  
PORCELAIN



**ZENESIS™ GRADE**

- 10mm (.394") segment height
- ZENESIS™ Porcelain Tile Blade is designed for professionals looking for fast, smooth and chip free cuts on ceramic and all types of porcelain, including large porcelain sheets and porcelain pavers. The continuous rim minimizes chipping and reduces the risk of blade flexing and segment loss.
- **Do not use for radius cutting**

**APPLICATIONS** - Porcelain Tile, Porcelain Pavers

CALL FOR PRICING

Size	Part #
4 x .063 x 7/8"-20mm-5/8"	<b>S-0406CWPZ</b>
4 1/2 x .063 x 7/8"-20mm-5/8"	<b>S-4506CWPZ</b>
7 x .063 x 5/8"	<b>S-0706AWPZ</b>
10 x .063 x 5/8"	<b>S-1006AWPZ</b>

## ZENESIS™ GLASS

GLASS



### ZENESIS™ GRADE

- 7.5mm (.295") segment height
- The new ZENESIS™ Glass Tile Blade provides chip-free performance significantly beyond anything currently available on the market. Independent testing has shown this blade to provide superior performance on all types and thicknesses of glass
- Provides smooth clean cuts on hard porcelain.
- **Do not use for radius cutting**

**APPLICATIONS** - Glass Tile, Glass Block, Soft Brittle Marble

CALL FOR PRICING

Size	Part #
4 x .063 x 7/8-20mm-5/8"	<b>S-0406CWGZ</b>
4 1/2 x .063 x 7/8-20mm-5/8"	<b>S-4506CWGZ</b>
7 x .063 x 5/8"	<b>S-0706AWGZ</b>
10 x .063 x 5/8"	<b>S-1006AWGZ</b>

## X401 THIN TURBO

PORCELAIN



### SUPREME GRADE

- 10mm (.394") segment height
- This blade is the go-to for just about everything. Cuts the hardest tiles and stone. Our testing on 3/4" porcelain pavers proved this blade to be the best against all our competitors' porcelain blades. The clean cuts from the unique thin turbo rim design will surprise you.
- **Do not use for radius cutting**

**APPLICATIONS** - Porcelain Tile, Ceramic Tile, Porcelain Pavers

Size	Part #	List Price
4 x .050 x 7/8-5/8", Hub	0406C4PDX4	\$59.93
4 1/2 x .050 x 7/8-5/8", Hub	4506C4PDX4	\$73.01
5 x .050 x 7/8-5/8", Hub	0506C4PDX4	\$79.07
6 x .063 x 7/8-5/8", Hub	0606C4PDX4	\$92.63
7 x .063 x U/A-7/8-5/8", Hub	0706U4PDX4	\$138.94
10 x .063 x 5/8", Hub	1006A4PDX4	\$217.94
12 X .087 X 1	1209E4PDX4	\$294.23
14 x .110 x 1, No Hub	1411E4PDX4	\$326.91

## X400 MUSIC SLOT

PORCELAIN



### SUPREME GRADE

- 10mm (.394") slotted rim height
- Incredible long life for the hardest porcelain
- **Do not use for radius cutting**

**APPLICATIONS** - Porcelain Tile, Ceramic Tile

Size	Part #	List Price
4 x .063 x 5/8"	0406APWX4	\$61.33
7 x .063 x 5/8"	0706APWX4	\$94.37
8 x .063 x 5/8"	0806APWX4	\$114.01
10 x .063 x 5/8"	<b>1006APWX4</b>	\$133.86
12 x .080 x 50/60mm	1208LPWX4	\$249.03
14 x .080 x 50/60mm	1408LPWX4	\$264.56

**NEW**

**X400 J-SLOT**  
PORCELAIN



**SUPREME GRADE**

- 6.5mm (.256") segment height
- **Do not use for radius cutting**

APPLICATIONS - Porcelain Tile, Ceramic Tile

Size	Part #	List Price
7 x .050 x 5/8"	0705APWX4J	\$82.58
10 x .050 x 5/8"	<b>1005APWX4J</b>	\$119.25

**X400**  
PORCELAIN



**SUPREME GRADE**

- 10mm (.394") continuous rim height, incredible long life for the hardest porcelain
- **Do not use for radius cutting**

APPLICATIONS - Porcelain Tile, Ceramic Tile

Size	Part #	List Price
4 x .063 x 5/8"	0406APWX4-NMS	\$61.33
4 1/2 x .063 x 5/8"	4506APWX4-NMS	\$65.60
5 x .063 x 5/8"	0506APWX4-NMS	\$69.43
7 x .063 x 5/8"	0706APWX4-NMS	\$94.37
8 x .063 x 5/8"	0806APWX4-NMS	\$114.01
10 x .060 x 5/8"	1006APWX4-NMS	\$133.86
12 x .080 x 50/60mm	1208LPWX4-NMS	\$249.03
14 x .080 x 50/60mm	1408LPWX4-NMS	\$264.56

**X300 THIN T-SLOT**  
PORCELAIN



**PREMIUM GRADE**

- 7.5mm (.295") continuous rim height
- Great for chip free cuts on all tiles and natural stone
- Designed for small hand held machines to run dry at high RPMs
- Large circular laser cut outs help to keep blade from overheating
- **Do not use for radius cutting**

APPLICATIONS - Porcelain Tile

Size	Part #	List Price
4 x .063 x 7/8"-20mm-5/8"	0406APDX3	\$49.52
4 1/2 x .063 x 7/8"-20mm-5/8"	4506APDX3	\$52.67
5 x .063 x 7/8"-20mm-5/8"	<b>0506APDX3</b>	\$58.29

**X300**  
PORCELAIN



**PREMIUM GRADE**

- 10mm (.394") continuous rim height
- E Slot
- Designed for the harder and thicker porcelains now on the market
- **Do not use for radius cutting**

APPLICATIONS - Porcelain Tile, Ceramic Tile

Size	Part #	List Price
4 x .060 x 3/8	0406APWX3	\$58.05
6 x .060 x 3/8	0606APWX3	\$83.04
7 x .060 x 3/8	<b>0706APWX3</b>	\$90.29
8 x .060 x 3/8	<b>0806APWX3</b>	\$102.67
8 x .080 x 3/8	0808APWX3	\$130.70
9 x .060 x 3/8	0906APWX3	\$122.40
10 x .060 x 3/8	<b>1006APWX3</b>	\$127.55
10 x .080 x 3/8	1008APWX3	\$170.18
10 x .080 x 7/8-5/8	1008CPWX3	\$170.18
12 x .080 x 1	1208EPWX3	\$239.68
14 x .080 x 1	<b>1408EPWX3</b>	\$239.68

**X300**  
GLASS TILE



**PREMIUM GRADE**

- 7.5mm (.295") continuous rim height
- High concentration of fine, top quality diamonds give the smoothest cut of any blade we offer
- Badly chipped glass tiles are never acceptable, the solution is here
- **Do not use for radius cutting**

APPLICATIONS - Glass Tile

Size	Part #	List Price
4 x .060 x 3/8	<b>0405AGWX3</b>	\$88.19
5 x .060 x 3/8	0505AGWX3	\$114.11
5 x .060 x 7/8-5/8	<b>0505CGWX3</b>	\$114.11
7 x .060 x 3/8	<b>0705AGWX3</b>	\$145.19
8 x .060 x 3/8	0805AGWX3	\$154.53
10 x .060 x 3/8	<b>1005AGWX3</b>	\$192.96
12 x .080 x 1	1208EGWX3	\$326.81
14 x .080 x 1	<b>1408EGWX3</b>	\$453.31

**X400**  
CERAMIC



**SUPREME GRADE**

- 10mm (.394") continuous rim height, for unbelievable long life
- Premium grade diamonds and technology make this the best ceramic blade on the market
- **Do not use for radius cutting**

APPLICATIONS - Porcelain Tile, Ceramic Tile

Size	Part #	List Price
4 x .060 x 3/8	0406ATWX4	\$45.67
4 x .060 x 7/8-5/8	0406CTWX4	\$45.67
4 1/2 x .060 x 3/8	4506ATWX4	\$62.26
4 1/2 x .060 x 7/8-5/8	4506CTWX4	\$62.26
5 x .060 x 7/8-5/8	0506CTWX4	\$64.30
6 x .060 x 3/8	0606ATWX4	\$66.34
6 x .060 x 7/8-5/8	0606CTWX4	\$66.34
7 x .060 x 3/8	<b>0706ATWX4</b>	\$73.70

Size	Part #	List Price
7 x .060 x DM-5/8	<b>0706DTWX4</b>	\$73.70
8 x .060 x 3/8	<b>0806ATWX4</b>	\$79.89
8 x .060 x DM-5/8	<b>0806DTWX4</b>	\$79.89
10 x .060 x 3/8	<b>1006ATWX4</b>	\$103.72
10 x .060 x 1	<b>1006ETWX4</b>	\$103.72
12 x .080 x 1	1208ETWX4	\$179.52
14 x .080 x 1	<b>1408ETWX4</b>	\$202.31



**X300**  
CERAMIC



**PREMIUM GRADE**

- 7.5mm (.295") continuous rim height
- Designed for the professional tile setter
- Super clean chip free cuts on ceramic tile, Saltillo tile and natural stone
- Not for extremely hard tile applications
- **Do not use for radius cutting**

APPLICATIONS - Ceramic Tile, Porcelain Tile

Size	Part #	List Price
4 x .060 x ½"	0406ATWX3	\$39.47
4 x .060 x ¾"	0406CTWX3	\$39.47
4½ x .060 x ½"	4506ATWX3	\$43.57
5 x .060 x ¾"	0506CTWX3	\$49.82
6 x .060 x ½"	0606ATWX3	\$56.06
6 x .060 x ¾"	0606CTWX3	\$56.06
7 x .060 x ½"	<b>0706ATWX3</b>	\$60.16
7 x .060 x ¾"	<b>0706CTWX3</b>	\$60.16

Size	Part #	List Price
8 x .060 x ½"	<b>0806ATWX3</b>	\$66.34
8 x .060 x ¾"	<b>0806CTWX3</b>	\$66.34
10 x .060 x ½"	<b>1006ATWX3</b>	\$90.29
10 x .060 x ¾"	1006CTWX3	\$90.29
10 x .060 x 1"	<b>1006ETWX3</b>	\$90.29
12 x .080 x 1"	1208ETWX3	\$164.93
14 x .080 x 1"	<b>1408ETWX3</b>	\$188.75

**X100**  
CERAMIC



**VALUE GRADE**

- 10mm (.394") continuous rim height
- Clean, chip free cuts on natural stone
- Great value and performance
- Not for extremely hard tile applications
- **Do not use for radius cutting**

APPLICATIONS - Ceramic Tile

Size	Part #	List Price
4 x .060 x ½"	<b>0406ATWX1</b>	\$31.07
4 x .060 x ¾"	<b>0406CTWX1</b>	\$31.07
4½ x .060 x ½"	<b>4506ATWX1</b>	\$37.38
4½ x .060 x ¾"	<b>4506CTWX1</b>	\$37.38
5 x .060 x ½"	<b>0506ATWX1</b>	\$43.57
5 x .060 x ¾"	<b>0506CTWX1</b>	\$43.57
6 x .060 x ½"	<b>0606ATWX1</b>	\$51.86
6 x .060 x ¾"	<b>0606CTWX1</b>	\$51.86

Size	Part #	List Price
7 x .060 x ½"	<b>0706ATWX1</b>	\$56.99
7 x .060 x ¾"	<b>0706CTWX1</b>	\$56.99
8 x .060 x ½"	<b>0806ATWX1</b>	\$59.10
10 x .060 x ½"	<b>1006ATWX1</b>	\$82.00
10 x .060 x ¾"	<b>1006CTWX1</b>	\$82.00
12 x .080 x 1"	1208ETWX1	\$143.20
14 x .080 x 1"	<b>1408ETWX1</b>	\$160.84

**X300**  
GENERAL PURPOSE



**PREMIUM GRADE**

- 7.5mm (.284") continuous rim height
- This professional grade continuous rim blade uses the most current technology to cut the hardest materials chip free without water
- **Do not use for radius cutting**

APPLICATIONS - Ceramic Tile, Porcelain Tile

Size	Part #	List Price
4 x .060 x ½"	0406ATDX3	\$51.06
4 x .060 x ¾"	<b>0406CTDX3</b>	\$51.06
4½ x .060 x ½"	<b>4506ATDX3</b>	\$53.97
4½ x .060 x ¾"	<b>4506CTDX3</b>	\$60.16
5 x .060 x ¾"	<b>0506CTDX3</b>	\$66.00
6 x .060 x ½"	0606ATDX3	\$74.64
7 x .060 x ¾"	0706CTDX3	\$91.46

Size	Part #	List Price
7 x .060 x DM-½"	0706DTDX3	\$91.46
8 x .060 x ½"	0806ATDX3	\$92.27
8 x .060 x DM-½"	0806DTDX3	\$92.27
10 x .060 x ½"	<b>1006ATDX3</b>	\$118.32
10 x .060 x ¾"	1006CTDX3	\$118.32
12 x .080 x 1"	1208ETDX3	\$208.50
14 x .080 x 1"	<b>1408ETDX3</b>	\$238.63

### Y100

GENERAL PURPOSE



### ◇◇ QUALITY GRADE

- 7mm (.284") continuous rim height
- 2x times taller rim than most dry tile blades
- Good for a variety of materials like ceramic tile, Saltillo tile and Cantera stone
- **Do not use for radius cutting**

APPLICATIONS - Ceramic Tile

Size	Part #	List Price
4 x .080 x 7/8-5/8	<b>0406CTDY2</b>	\$15.30
4 1/2 x .080 x 7/8-5/8	<b>4506CTDY2</b>	\$16.11
7 x .090 x 5/8	<b>0706ATDY2</b>	\$32.70
10 x .090 x 5/8	<b>1006ATDY2</b>	\$52.67

### PROFILE WHEEL

GENERAL PURPOSE



- The best and fastest way to bevel or bullnose tile is with our 6" and 8" tile saw wheels. This is a professional grade, production tool that can shape marble, ceramic, granite and even the hardest porcelain tiles. Not to be confused with other brands that use electroplated or brazed diamonds, our blades have a metal bond with multiple layers of diamond to outlast all others.

APPLICATIONS - Marble, Ceramic, Granite, Hard Porcelain Tile

### AVAILABLE SHAPES



Size	Type	Part #	List Price
6 x .375 x 5/8	Demi Bullnose, Shape B	<b>S-0637AWPC-B</b>	\$487.63
6 x .500 x 5/8	Demi Bullnose, Shape B	S-0650AWPC-B	\$544.84
8 x .375 x 5/8	Demi Bullnose, Shape B	S-0837AWPC-B	\$678.34
8 x .500 x 5/8	Demi Bullnose, Shape B	S-0850AWPC-B	\$724.65
6 x .375 x 5/8	Bevel, Shape E	S-0637AWPC-E	\$636.68
6 x .500 x 5/8	Bevel, Shape E	S-0650AWPC-E	\$689.23
6 x .500 x 5/8	Ogee, Shape F	S-0650AWPC-F	\$934.42

### DRESSING STONES

FOR BLADES



- Keep your tile and stone blades at their premium performance level with abrasive dressing stones from Diamond Vantage®
- Today's natural and man-made materials can quickly glaze even the best diamond blade
- If you wait for a blade to become dull, it can cause serious damage to your material and even damage the blade
- Coarse sharp abrasives in the dressing stone quickly expose new diamonds to keep your cuts clean and eliminate blow out at the beginning or end of a cut
- For those materials that are hard, dense, and difficult to cut, we recommend dressing the blade frequently

APPLICATIONS - Used for dressing tile and bridge saw blades to prevent chipping

Size	Grit	Part #	List Price
8 x 2 x 1	60	S-0821DS	\$19.06

## CORE BITS - 43MM

GENERAL PURPOSE



### PREMIUM GRADE

- 5.5mm (.216") segment height, will yield maximum number of holes
- Sizes over 1" equipped with pilot drill
- These premium grade core bits have a male stem to run on any hand drill
- The turbo rim is designed for fast, clean drilling
- 43mm drilling depth

**APPLICATIONS** - Porcelain Tile, Ceramic Tile, Granite, Marble

Size	Part #	List Price
½ x .080 x 10mm	<b>ST-00508SDTRCB</b>	\$99.94
¾ x .080 x 10mm	<b>ST-00608SDTRCB</b>	\$103.98
¾ x .080 x 10mm	<b>ST-00708SDTRCB</b>	\$103.98
7⁄8 x .080 x 10mm	<b>ST-00808SDTRCB</b>	\$104.96
1 x .080 x 10mm	<b>ST-01008SDTRCB</b>	\$104.96
1 ½ x .080 x 10mm	<b>ST-01108SDTRCB</b>	\$109.00

Size	Part #	List Price
1 ¼ x .080 x 10mm	<b>ST-01208SDTRCB</b>	\$109.00
1 ¾ x .080 x 10mm	<b>ST-01308SDTRCB</b>	\$109.00
1 ½ x .080 x 10mm	<b>ST-01508SDTRCB</b>	\$121.98
1 ¾ x .080 x 10mm	<b>ST-01608SDTRCB</b>	\$126.02
1 ¾ x .080 x 10mm	<b>ST-01708SDTRCB</b>	\$138.03

## CORE BITS - 35MM

GENERAL PURPOSE



### PREMIUM GRADE

- 5.5mm (.216") segment height
- Sizes over 1" equipped with pilot drill
- Same great quality as our turbo tile bits. Designed to run on any grinder or polisher with 5⁄8"-11 male thread
- Approximate 35mm drilling depth

**APPLICATIONS** - Porcelain Tile, Ceramic Tile, Granite, Marble

Size	Part #	List Price
1 x .080 x 5⁄8 -11	ST-01008HDTRCB	\$108.02
1 ½ x .080 x 5⁄8 -11	ST-01108HDTRCB	\$109.00
1 ¼ x .080 x 5⁄8 -11	<b>ST-01208HDTRCB</b>	\$112.92
1 ¾ x .080 x 5⁄8 -11	<b>ST-01308HDTRCB</b>	\$112.92
1 ½ x .080 x 5⁄8 -11	<b>ST-01508HDTRCB</b>	\$124.92
1 ¾ x .080 x 5⁄8 -11	ST-01708HDTRCB	\$141.94
2 x .080 x 5⁄8 -11	<b>ST-02008HDTRCB</b>	\$141.94

## DIAMOND HAND PADS

STONE



- Our hand polishing pads have so many uses it is almost limitless. Originally designed for doing repairs on stone without power tools
- We have also found them to be great for taking off sharp edges on porcelain tile, removing calcium from swimming pool tiles and prepping concrete overlays
- Available individually or in sets from 50 – 3000 grit

**APPLICATIONS** - Repairing Natural and Engineered Stone, Edge Polishing Ceramic and Porcelain Tile

Size	Part #	List Price
Electroplated #50	<b>S-HPPEL-50</b>	\$79.01
Electroplated #100	<b>S-HPPEL-100</b>	\$79.01
Electroplated #200	<b>S-HPPEL-200</b>	\$79.01
Electroplated #400	<b>S-HPPEL-400</b>	\$79.01
Resin #800	S-HPRE-800	\$79.01
Resin #1500	<b>S-HPRE-1500</b>	\$79.01
Resin #3000	<b>S-HPRE-3000</b>	\$79.01





# STONE PRODUCTS

## STONE PRODUCTS PERFORMANCE CHART



**NEW**

### ZENESIS™ CARBON 2 SINTERED STONE



#### ZENESIS™ GRADE

- 10mm (.394") segment height
- Introducing the groundbreaking ZENESIS™ Carbon 2 diamond blade, designed for superior performance in cutting critically hard sintered stones such as Dekton, Neolith, and Lapitec. Experience exceptional results even at high speeds, as these blades deliver a precision razor-sharp edge on both the top and bottom surfaces, ensuring unparalleled quality, especially during miter cutting. Crafted with the highest quality steel core and reinforced with plates to eliminate flexing and deflection during extended cuts, the ZENESIS™ Carbon 2 sets a new standard in durability and stability. This cutting-edge blade utilizes Sinterized Particle Tech to masterfully cut through ultracompact surfaces created by blending glass, porcelain, and quartz materials. Elevate your stone cutting experience with the ZENESIS™ Carbon 2 – where precision meets perfection in the stone industry.

**APPLICATIONS** - Porcelain, Sintered Stone, Petrified Wood, Slabs Made With Geodes

CALL FOR PRICING

Size	Part #
12 x .125 x 60/50mm	<b>S-1210LWZX4-CARB2</b>
14 x .125 x 60/50mm	<b>S-1410LWZX4-CARB2</b>
16 x .125 x 60/50mm	<b>S-1613LWZX4-CARB2</b>



PART #'S IN BOLD INDICATE ROUTINELY STOCKED PRODUCTS



## ZENESIS™ OBSIDIAN

NATURAL & ENGINEERED STONE



### ZENESIS™ GRADE

- 25mm (.984") segment height
- Meet the newest ZENESIS™ silent core bridge saw blade, Obsidian. Distinctly designed to cut fast and clean on engineered stone, porcelain, marble, and even the hardest quartzite. This is made possible by using our latest and most innovative ZENESIS™ diamond patterning technology to date. This latest technology increases the number of cutting/contact points by up to 3 times and significantly improves performance. The unique metal bond matrix is engineered to work with virtually all natural and engineered stone.

**APPLICATIONS** - Granite, Engineered Stone, Porcelain, Marble, Quartzite

CALL FOR PRICING

Size	Part #
12 x .133 x 60/50mm	<b>S-1213LWZX4-OBS</b>
14 x .133 x 60/50mm	<b>S-1413LWZX4-OBS</b>
16 x .133 x 60/50mm	<b>S-1613LWZX4-OBS</b>
18 x .140 x 60/50mm	<b>S-1814LWZX4-OBS</b>
20 x .140 x 60/50mm	<b>S-2014LWZX4-OBS</b>

## ZENESIS™ BLACK 4

NATURAL & ENGINEERED STONE



### ZENESIS™ GRADE

- 25mm (.984") segment height
- ZENESIS™ patterned technology delivers consistency in diamond exposure, providing maximum efficiency start to finish. With feed rates exceeding 15 ft/min this blade outperforms random diamond bridge saw blades by 30 – 70%. This further increases cutting speed and debris/swarf removal. Diamond clusters provide more diamond point exposure, which increases cutting speed with less amp draw and therefore is easier on machinery. ZENESIS™ products are manufactured utilizing the highest standards of manufacturing in ISO certified facilities. This delivers consistent results blade after blade and batch after batch.
- The ZENESIS™ Black 4 blade is built on high quality, slanted gullet silent cores. Strong cores keep segments cutting true even when mitering, and the slanted gullets draw in more water and push out more swarf/debris resulting in cleaner cuts.
- Designed to outperform all other bridge saw blade on straight or mitered cuts

**APPLICATIONS** - Granite, Engineered Stone, Quartzite

CALL FOR PRICING

Size	Part #
12 x .133 x 60/50mm	<b>S-1213LWZX4-BLK4</b>
14 x .133 x 60/50mm	<b>S-1413LWZX4-BLK4</b>
16 x .133 x 60/50mm	<b>S-1613LWZX4-BLK4</b>

Size	Part #
18 x .140 x 60/50mm	<b>S-1814LWZX4-BLK4</b>
18 x .187 x 60/50mm	S-1818LWZX4-BLK4
20 x .140 x 60/50mm	<b>S-2014LWZX4-BLK4</b>

## ZENESIS™ NANO

PORCELAIN



### ZENESIS™ GRADE

- The latest generation of porcelain tiles, require cutting edge technology to get the perfect chip free cuts. The new 14" silent core Nano is a hybrid blade specifically engineered to cut fast and unbelievably clean on these tricky materials. The heavy-duty silent core keeps the blade cutting true even in long miter cuts.
- High concentration small particulate diamond in very soft bond matrix
- Can cut large format porcelain

**APPLICATIONS** - Glass Coated Porcelain, Porcelain

CALL FOR PRICING

Size	Part #
14 x .135 x 60/50mm	S-1413LWZX4-NZG
16 x .135 x 60/50mm	S-1613LWZX4-NZG

**ZENESIS™ QUARTZITE**  
QUARTZITE



**ZENESIS™ GRADE**

- 20mm (.787") segment height
- Quartzite is a unique natural rock made up of interlocking quartz crystals resulting in a remarkably dense and hard rock. A specialized blade is required to quickly and cleanly cut a material of this quality. The ZENESIS™ Quartzite blade provides superior cutting performance on quartzite.
- Unique segment design for fast cutting speeds; has cut Taj Mahal at over 6 ft./min. feed rate
- Patterned diamond matrix for straight chip-free cuts
- Soft bond for continuous use without dressing

**APPLICATIONS** - Granite, Engineered Stone, Quartzite

CALL FOR PRICING

Size	Part #
12 x .125 x 60/50mm	<b>S-1212LWZX4-20Q</b>
14 x .125 x 60/50mm	<b>S-1412LWZX4-20Q</b>
16 x .134 x 60/50mm	<b>S-1613LWZX4-20Q</b>
18 x .150 x 60/50mm	<b>S-1815LWZX4-20Q</b>
20 x .150 x 60/50mm	S-2015LWZX4-20Q

**ZENESIS™ II**  
NATURAL & ENGINEERED STONE



**ZENESIS™ GRADE**

- 25mm (.984") segment height
- The ZENESIS™ II bridge saw blade revolutionized the stone fabricating industry by raising the bar for cutting speed and blade life. Straight and efficient cutting increases productivity while reducing stress on the bridge saw.
- Feed rate 10 to 17 feet per minute

**APPLICATIONS** - Granite, Engineered Stone

CALL FOR PRICING

Size	Part #
12 x .125 x 60/50mm	<b>S-1212LWZX4-25C</b>
14 x .125 x 60/50mm	<b>S-1412LWZX4-25C</b>
16 x .125 x 60/50mm	<b>S-1612LWZX4-25C</b>
18 x .140 x 60/50mm	<b>S-1814LWZX4-25C</b>
20 x .140 x 60/50mm	S-2014LWZX4-25C

**ZENESIS™ MARBLE**  
MARBLE



**ZENESIS™ GRADE**

- 10mm (.394") segment height
- ZENESIS™ now offers its exclusive patterned technology in a bridge saw blade designed specifically to cut marble and other soft stone products. As expected, this latest ZENESIS™ Marble blade offers exceptionally smooth, fast and chip-free cutting on all types of marble. This blade is available in diameters of 12" to 20" and is guaranteed to set the standard of performance and meet the demands of marble fabricators everywhere.
- Designed specifically to cut marble
- Exceptionally smooth, fast, chip-free cutting
- Silent core

**APPLICATIONS** - Marble

CALL FOR PRICING

Size	Part #
12 x .125 x 60/50mm	<b>S-1212LWMSZX4</b>
14 x .125 x 60/50mm	<b>S-1412LWMSZX4</b>
16 x .125 x 60/50mm	<b>S-1612LWMSZX4</b>
18 x .140 x 60/50mm	<b>S-1814LWMSZX4</b>
20 x .140 x 60/50mm	<b>S-2014LWMSZX4</b>

## ZENESIS™ Z-PATTERN

NATURAL & ENGINEERED STONE



### ZENESIS™ GRADE

- 18mm (.708") segment height
- The ZENESIS™ Z-Pattern Blade is recommended for production shops utilizing CNC and robotic stone saws. These new technology saws require speed, accuracy and clean cuts. The 18mm pattern diamond segments are specifically designed to run faster and straighter under extreme production conditions. This high-performing blade has been expertly developed for wet use only on granite and engineered stone and is proven to perform reliably at feed rates 5-10 feet per minute. Can be used on quartzite at feed rates 1-4 feet per minute.

**APPLICATIONS** - Granite, Engineered Stone

Size	Part #
12 x .125 x 60/50mm	S-1212LWZX4-ZP
14 x .125 x 60/50mm	S-1412LWZX4-ZP
16 x .125 x 60/50mm	S-1612LWZX4-ZP
18 x .140 x 60/50mm	S-1814LWZX4-ZP
20 x .140 x 60/50mm	S-2014LWZX4-ZP

## X400-20MM

NATURAL & ENGINEERED STONE



### ❖ SUPREME GRADE

- 20mm (.787") segment height
- Pattern diamond technology guarantee maximum performance start to finish
- Silent core for indoor use
- Proprietary recipe bond that cuts the hardest natural stone, including quartzite, and engineered stone effortlessly
- Excellent miter cutting blade
- Slanted gullets draw in more water to keep blade running cooler

**APPLICATIONS** - Granite, Quartzite, Engineered Stone

Size	Part #	List Price
12 x .125 x 60/50mm	<b>S-1212LWPX4-20</b>	\$723.70
14 x .125 x 60/50mm	<b>S-1412LWPX4-20</b>	\$816.19
16 x .125 x 60/50mm	<b>S-1612LWPX4-20</b>	\$948.72
18 x .140 x 60/50mm	<b>S-1814LWPX4-20</b>	\$1,250.02
20 x .140 x 60/50mm	<b>S-2014LWPX4-20</b>	\$1,556.09

## X400-25MM

NATURAL & ENGINEERED STONE

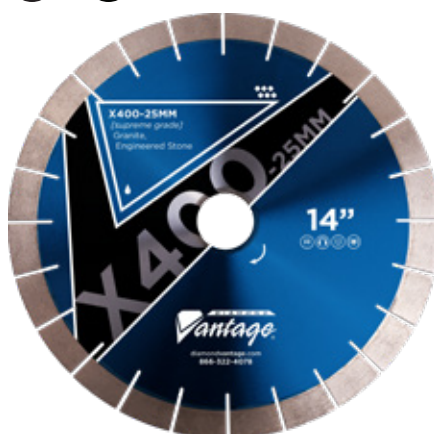

### ❖ SUPREME GRADE

- 25mm (.984") segment height
- Pattern diamond technology guarantee maximum performance start to finish
- Silent core for indoor use
- Proprietary recipe bond that cuts the hardest natural stone and engineered stone effortlessly

**APPLICATIONS** - Granite, Quartzite, Engineered Stone

Size	Part #	List Price
12 x .125 x 60/50mm	S-1212LWPX4-25	\$800.93
14 x .125 x 60/50mm	<b>S-1412LWPX4-25</b>	\$928.97
16 x .125 x 60/50mm	<b>S-1612LWPX4-25</b>	\$1,116.94
18 x .140 x 60/50mm	S-1814LWPX4-25	\$1,454.75
20 x .140 x 60/50mm	S-2014LWPX4-25	\$1,773.49

### X400-Q

NATURAL & ENGINEERED STONE



#### SUPREME GRADE

- 20mm (.787") segment height
- Quartzite is quickly becoming one of the most popular stones for counter tops. It is one of the least popular for fabricators as it can be extremely difficult to cut. It can be simultaneously incredibly hard and very brittle. This blade is specifically designed with a very soft bond matrix to cut very hard materials like any other natural stone.

**APPLICATIONS** - Granite, Engineered Stone

Size	Part #	List Price
12 x .125 x 60/50mm	S-1212LWX4-20Q	\$672.87
14 x .125 x 60/50mm	S-1412LWX4-20Q	\$806.36
16 x .134 x 60/50mm	S-1613LWX4-20Q	\$1,013.46
18 x .155 x 60/50mm	S-1815LWX4-20Q	\$1,272.23
20 x .155 x 60/50mm	S-2015LWX4-20Q	\$1,492.88

### X300-10MM

MARBLE



#### PREMIUM GRADE

- 10mm (.394") segment height - have less chance of "flexing" while miter cutting
- Silent core for indoor use
- Clean Cutting
- Smaller diamond particulate gives blade perfect chip free cuts in soft materials like marble and limestone
- Highest diamond concentrate of all our bridge saw blades

**APPLICATIONS** - Marble, Limestone

Size	Part #	List Price
12 x .125 x 60/50mm	S-1212LWMS	\$570.58
14 x .125 x 60/50mm	<b>S-1412LWMS</b>	\$674.30
16 x .125 x 60/50mm	<b>S-1612LWMS</b>	\$778.01
18 x .125 x 60/50mm	<b>S-1812LWMS</b>	\$1,072.71
20 x .140 x 60/50mm	S-2014LWMS	\$1,328.86

### THIN VENEER

THIN VENEER

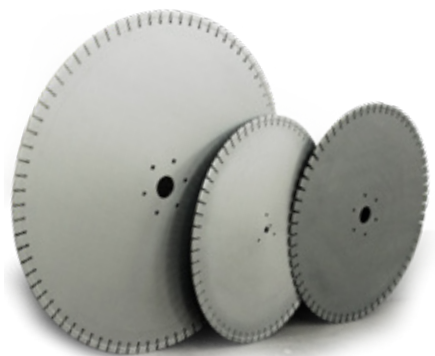

#### CUSTOMIZABLE GRADE

- The large diameter blades for thin veneer stone from Diamond Vantage® are designed to fit the thin veneer saws. The tall 20mm segments ensure consistent performance and long blade life, increasing your productivity by reducing machine downtime.
- Additional sizes/arbor available upon request
- Different bonds available for different types of stone

**APPLICATIONS** - Thin Veneer

Size	Part #	List Price
36 x .250	S-3625XWX4	\$3,499.39
40 x .250	S-4025XWX4	\$3,909.36
48 x .250	S-4825XWX4	\$4,644.05



**NEW****ZENESIS™ Z-MAX**

NATURAL &amp; ENGINEERED STONE

**ZENESIS™ GRADE**

- Introducing the cutting-edge Z-Max Turbo Blade, the epitome of high-performance in small-diameter stone blades. Its distinctive segment design ensures remarkably fast and precise cuts in both natural and engineered stones. Experience unparalleled efficiency as this blade effortlessly navigates through any stone surface. The Z-Max Turbo Blade features oversized cooling holes that prevent overheating, even when cutting through 3cm quartzite. This ensures consistent and reliable performance, making it the go-to choice for demanding stone-cutting applications.
- Flush cut adapter sold separately
- Available with quad adaptor holes in sizes 4.5", 5.3", 6", 7"

**APPLICATIONS** - Granite, Engineered Stone, Quartzite

CALL FOR PRICING

Size	Part #
4½ x .080 x 7/8-20mm-5/8	S-4510CDZTB3
5 1/3 x .080 x 7/8-20mm-5/8	S-05310CDZTB3
6 x .095 x 7/8-20mm-5/8	S-0610CDZTB3
7 x .095 x U/A-5/8	S-0710UDZTB3

**ZENESIS™ QUARTZITE**

NATURAL &amp; ENGINEERED STONE

**ZENESIS™ GRADE**

- 10mm (.394") segment height
- The new ZENESIS™ Quartzite turbo blade is the first small-diameter blade we engineered specifically for the hardest quartzite. Where other turbo blades bounce, chip, or stop cutting after a few inches, this blade cuts easily through this material. Unique turbo rim design with added drop segments makes this blade immediately stand out from the competition. And if you think it does well in quartzite, you'll be amazed at how it works in any other natural stone.
- Available with quad adaptor holes in sizes 5" to 7".
- Unique turbo rim design
- Flush cut adapter sold separately

**APPLICATIONS** - Quartzite, All Natural Stone, Granite, Engineered Stone

CALL FOR PRICING

Size	Part #
5 x .083 x 7/8-20mm-5/8	<b>S-0508CDZQB</b>
6 x .095 x 7/8-20mm-5/8	<b>S-0609CDZQB</b>
7 x .095 x U/A-7/8-5/8	<b>S-0709UDZQB</b>

**ZENESIS™ Z-TURBO**

NATURAL &amp; ENGINEERED STONE

**ZENESIS™ GRADE**

- 8mm (.315") segment height
- Delivering fast and clean cuts at an affordable price, the new ZENESIS™ Z-Turbo Blade gives you maximum value. The blade's narrow turbo design effectively reduces chipping. It comes with flush cut holes and a unique bond that maximizes performance on granite and engineered stone.
- Narrow turbo design reduces chipping
- Flush cut adapter sold separately

**APPLICATIONS** - Granite, Engineered Stone

CALL FOR PRICING

Size	Part #
4½ x .083 x 7/8-20mm-5/8	S-4508CDZETB2
5 x .083 x 7/8-20mm-5/8	S-0508CDZETB2
6 x .095 x 7/8-20mm-5/8	S-0609CDZETB2
7 x .095 x U/A-7/8-5/8	S-0709UDZETB2

**X400 WAVY CORE**  
HARD MATERIALS



**SUPREME GRADE**

- 10mm (.394") segment height
- Turbo rim design with side protection segments to prevent undercutting
- Best blade for outdoor stones like flagstone, granite and sandstone
- Wavy core increases airflow and keeps the blade running cooler

**APPLICATIONS** - Granite, Engineered Stone, Quartzite

Size	Part #	List Price
4½ x .080 x 7/8-5/8	<b>4508CZVX4-1WC</b>	\$84.21
5 x .080 x 7/8-5/8	<b>0508CZVX4-1WC</b>	\$89.47
6 X .095 X 7/8-5/8	<b>0609CZVX4-1WC</b>	\$116.45
7 X .095 X U/A	<b>0709UZVX4-1WC</b>	\$140.05

**X400**  
GRANITE & ENGINEERED STONE



**SUPREME GRADE**

- 8mm (.315") rim height
- Flush mount adapter ready
- Designed for the professional who demands the best quality
- Fast clean cuts in the hardest materials like granite and quartzite
- Flush cut adapter sold separately

**APPLICATIONS** - Granite, Engineered Stone, Quartzite

Size	Part #	List Price
4 x .100 x 7/8-20mm-5/8	<b>S-0408CDZX4-1</b>	\$72.62
4½ x .100 x 7/8-20mm-5/8	<b>S-4508CDZX4-1</b>	\$73.65
5 x .100 x 7/8-20mm-5/8	<b>S-0508CDZX4-1</b>	\$82.99
6 x .100 x 7/8-20mm-5/8	<b>S-0609CDZX4-1</b>	\$116.18
7 x .100 x U/A	<b>S-0709UDZX4-1</b>	\$146.27

**X200**  
GRANITE & ENGINEERED STONE

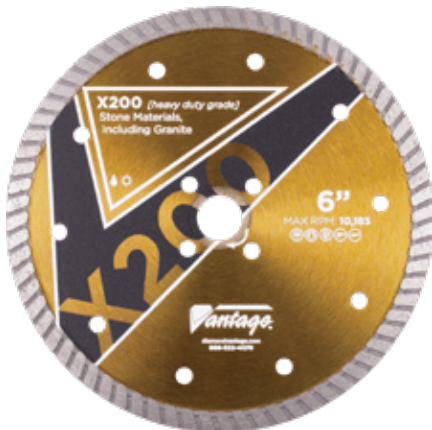

**HEAVY DUTY GRADE**

- 8mm (.315") rim height
- Flush mount adapter ready
- Great for granite, engineered stone, flagstone, sandstone and brick pavers
- Flush cut adapter sold separately

**APPLICATIONS** - Granite, Engineered Stone

Size	Part #	List Price
4 x .083 x 7/8-20mm-5/8	<b>S-0408CDZX2-1</b>	\$33.17
4½ x .083 x 7/8-20mm-5/8	<b>S-4508CDZX2-1</b>	\$36.32
5 x .083 x 7/8-20mm-5/8	<b>S-0508CDZX2-1</b>	\$41.47
6 x .095 x 7/8-20mm-5/8	<b>S-0609CDZX2-1</b>	\$50.81
7 x .095 x U/A-7/8-5/8	<b>S-0709UDZX2-1</b>	\$63.31

**X100**  
GRANITE & ENGINEERED STONE



◆◆◆ VALUE GRADE

- 8mm (.315") rim height
- Fast, clean cuts on hard granite and engineered stone
- Flush cut adapter sold separately

APPLICATIONS - Granite, Engineered Stone

Size	Part #	List Price
4 x .083 x 7/8-20mm-5/8"	S-0408CDZX1-1	\$29.20
4 1/2 x .083 x 7/8-20mm-5/8"	S-4508CDZX1-1	\$33.63
5 x .083 x 7/8-20mm-5/8"	S-0508CDZX1-1	\$36.32
6 x .095 x 7/8-20mm-5/8"	S-0609CDZX1-1	\$46.83
7 x .095 x U/A-7/8-5/8"	S-0709UDZX1-1	\$58.16

**X100**  
LIMESTONE & MARBLE

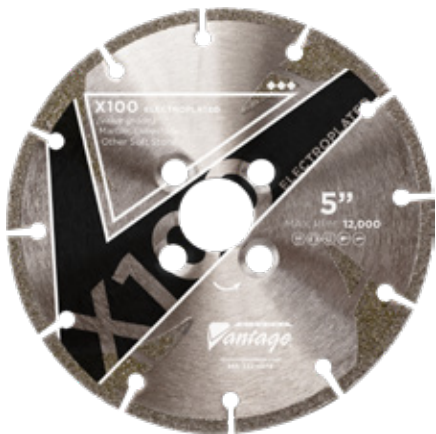

◆◆◆ VALUE GRADE

- For cutting marble, limestone, and other soft stone
- Equipped with side abrasive coating for fast and clean cuts
- Flush cut adapter sold separately

APPLICATIONS - Limestone, Marble

Size	Part #	List Price
4 1/2 x .102 x 7/8"	S-4510CELCW	\$60.84
5 x .102 x 7/8"	S-0510CELCW	\$68.76
6 x .102 x 7/8"	S-0610CELCW	\$76.70
7 x .102 x 7/8"	S-0710CELCW	\$103.15

**FLUSH CUT ADAPTER**  
FOR SMALL DIAMETER BLADES



- This adapter is a game changer in the world of diamond blades. For any small diameter blade with flush mount hole pattern. Allows flush cutting and deeper penetration with the blade. Easier for changing tools too as blade is now just spin on and spin off. No more locking nuts!

Size	Part #	List Price
4 Screw to 5/8" -11	FCA	\$26.44

**CONTOUR BLADE**  
SEGMENTED



**PREMIUM GRADE**

- 6.5mm (.255") segment height
- Segmented contour blade
- Contoured core for making radius cuts and cutting sink openings
- Unique T shaped segments to prevent blade binding while cutting
- Longest lasting
- Soft bond for cutting natural stone and concrete

**APPLICATIONS** - Granite, Engineered Stone

Size	Part #	List Price
4 x .150 x 7/8-5/8	S-0415CCS	\$158.74
4 1/2 x .150 x 7/8-5/8	S-4515CCS	\$163.87
5 x .150 x 7/8-5/8	<b>S-0515CCS</b>	\$176.37

**CONTOUR BLADE**  
TURBO



**PREMIUM GRADE**

- 6.5mm (.255") segment height
- Turbo rim contour blade
- Contoured core for making radius cuts and cutting sink openings
- Turbo style rim for fastest cutting
- Undercutting segments to prevent binding while cutting
- Soft bond for cutting natural stone and concrete

**APPLICATIONS** - All Natural Stone, Engineered Stone

Size	Part #	List Price
4 x .150 x 7/8-5/8	S-0415CCZ	\$158.74
4 1/2 x .150 x 7/8-5/8	S-4515CCZ	\$163.87
5 x .150 x 7/8-5/8	<b>S-0515CCZ</b>	\$176.37

**CONTOUR BLADE**  
ELECTROPLATED



**PREMIUM GRADE**

- 6.5mm (.255") segment height
- Electroplated turbo rim contour blade
- Contoured core for making radius cuts and cutting sink openings
- Turbo style rim for fastest cutting
- Electroplated bond for cutting marble, schist, and porcelain
- Offers a distinctly smooth cut in fragile materials like marble, schist, and porcelain

**APPLICATIONS** - All Natural Stone, Engineered Stone

Size	Part #	List Price
5 x .098 x 7/8	<b>S-0510CEPC</b>	\$112.83



**RODDING BLADE**  
NATURAL & ENGINEERED STONE

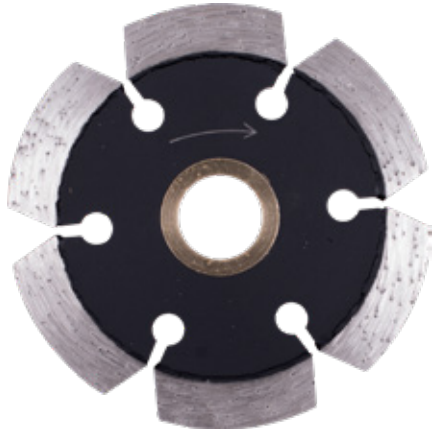

**PREMIUM GRADE**

- 10mm (.394") segment height
- Specifically designed for cutting a channel in the underside of counter tops
- 3.3" diameter blade - will guarantee not to blow through the surface of the stone
- 1/8" thickness for fish tape and fiberglass rodding material
- 1/4" thickness for thicker rodding material like all-thread
- Proprietary super soft bond for the hardest materials like granite and quartzite

**APPLICATIONS** - All Natural Stone, Engineered Stone

Size	Part #	List Price
3.3 x 1/8 x 7/8-5/8	<b>S-3312CRX4-1</b>	\$122.04
3.3 x 1/4 x 7/8-5/8	S-3325CRX4-1	\$177.36

**MULTI-GRINDER**  
NATURAL & ENGINEERED STONE



**PREMIUM GRADE**

- Cut & grind with one blade
- Comes with removable flush cut adaptor
- This unique 2-in-1 blade is the ultimate stone installer's tool
- Cuts and grinds the hardest materials like granite, engineered stone, flagstone and concrete pavers with ease

**APPLICATIONS** - All Natural and Engineered Stone

Size	Part #	List Price
4 x .100 x 7/8	0410CZCGX3-2	\$129.39
4 1/2 x .100 x 7/8	4510CZCGX3-2	\$139.49
5 x .100 x 7/8	0510CZCGX3-2	\$153.03
6 x .100 x 7/8	0610CZCGX3-2	\$178.87
7 x .100 x 7/8	0710CZCGX3-2	\$236.28

**MULTI-GRINDER EP**  
NATURAL STONE



**PREMIUM GRADE**

- Cutting - Continuous Rim Blade leaves a beautiful chip-free finish in even the most brittle calcium based stones like limestone, travertine, marble, and onyx
- Grinding - Electroplated diamonds on the face of the blade can sand and grind the material fast without blowouts like you get from traditional diamond cup wheels
- Comes with removable flush cut adaptor

**APPLICATIONS** - Limestone, Travertine, Marble, Onyx

Size	Part #	List Price
4 1/2 x .102 x 7/8 w/ 5/8-11	S-4506CELF	\$85.70
5 x .102 x 7/8 w/ 5/8-11	S-0506CELF	\$91.41

**ZENESIS™ CORE BITS**  
NATURAL & ENGINEERED STONE



CALL FOR PRICING

**ZENESIS™ GRADE**

- 8mm (.315") segment height
- ZENESIS™ Dry Core Bit is thoroughly engineered to achieve superior wet and dry coring of granite and engineered stone
- Available with 5/8-11 threads
- All-new design for enhanced performance
- Laser-welded segments for safer coring
- Larger cooling holes on the barrel
- Abrasive side coating to reduce friction
- Can be used wet or dry
- Approximate 77mm (3.03") drilling depth

**APPLICATIONS** - Granite, Engineered Stone

Size	Part #	Size	Part #
1 1/4 x .125 x 5/8-11	<b>S-01212HDZX4</b>	2 1/4 x .125 x 5/8-11	<b>S-02212HDZX4</b>
1 3/8 x .125 x 5/8-11	<b>S-01312HDZX4</b>	2 1/2 x .125 x 5/8-11	<b>S-02512HDZX4</b>
1 1/2 x .125 x 5/8-11	<b>S-01512HDZX4</b>	3 x .125 x 5/8-11	<b>S-03012HDZX4</b>
2 x .125 x 5/8-11	<b>S-02012HDZX4</b>		

**ZENESIS™ Z-CORE BITS**  
NATURAL & ENGINEERED STONE

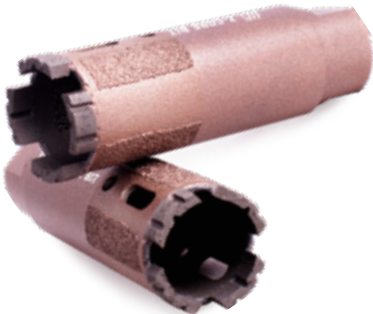

CALL FOR PRICING

**ZENESIS™ GRADE**

- 7mm (.275") segment height
- The all-new ZENESIS™ Z-Core Bit is engineered for optimal performance on granite and engineered stone. It is equipped with abrasive coating both inside and outside to reduce friction and to facilitate easy core removal. Featuring laser-welded segments for safety and long life, this product provides maximum value.
- Engineered for maximum performance on granite and engineered stone
- Can be used wet or dry
- Approximate 77mm (3.03") drilling depth

**APPLICATIONS** - Granite, Engineered Stone

Size	Part #
1 x .125 x 5/8-11	<b>S-01012HDSBSLZX4</b>
1 1/4 x .125 x 5/8-11	<b>S-01212HDSBSLZX4</b>
1 3/8 x .125 x 5/8-11	<b>S-01312HDSBSLZX4</b>
1 1/2 x .125 x 5/8-11	S-01512HDSBSLZX4
1 3/4 x .125 x 5/8-11	<b>S-01712HDSBSLZX4</b>
2 x .125 x 5/8-11	<b>S-02012HDSBSLZX4</b>

**RED CORE BITS**  
ALL NATURAL STONE



**PREMIUM GRADE**

- 7mm (.275") segment height
- Available with 5/8-11 threads
- For drilling of granite and engineered stone
- Equipped with side brazing on both inside and outside to prevent the bit from binding the hole and facilitate easy core removal
- Approximate 77mm (3.03") drilling depth

**APPLICATIONS** - All Natural Stone

Size	Part #	List Price
1 x .125 x 5/8-11	<b>S-01012HDSBSL</b>	\$146.30
1 1/8 x .125 x 5/8-11	S-01112HDSBSL	\$151.23
1 1/4 x .125 x 5/8-11	<b>S-01212HDSBSL</b>	\$155.20
1 3/8 x .125 x 5/8-11	<b>S-01312HDSBSL</b>	\$155.20
1 1/2 x .125 x 5/8-11	<b>S-01512HDSBSL</b>	\$163.98
1 3/4 x .125 x 5/8-11	<b>S-01712HDSBSL</b>	\$185.64
2 x .125 x 5/8-11	<b>S-02012HDSBSL</b>	\$192.49

## BLACK CORE BITS

ALL NATURAL STONE



### ZENESIS™ GRADE

- 8mm (.315") segment height
- Available with 5/8"-11 threads
- For drilling of granite and engineered stone
- Brazed diamonds on the side of the barrel prevent binding in the hole
- Brazed diamonds on the inside of the barrel make it easy to remove the plug after coring
- Approximate 77mm (3.03") drilling depth

**APPLICATIONS** - All Natural Stone

Size	Part #	List Price
1 x .125 x 5/8"-11	<b>S-01012HDSBSLX4</b>	\$146.30
1 1/4 x .125 x 5/8"-11	<b>S-01212HDSBSLX4</b>	\$146.41
1 3/8 x .125 x 5/8"-11	<b>S-01312HDSBSLX4</b>	\$155.20
1 1/2 x .125 x 5/8"-11	<b>S-01512HDSBSLX4</b>	\$163.98
1 3/4 x .125 x 5/8"-11	<b>S-01712HDSBSLX4</b>	\$185.64
2 x .125 x 5/8"-11	<b>S-02012HDSBSLX4</b>	\$192.49
2 1/4 x .125 x 5/8"-11	<b>S-02212HDSBSLX4</b>	\$216.07
2 1/2 x .125 x 5/8"-11	<b>S-02512HDSBSLX4</b>	\$240.61
3 x .125 x 5/8"-11	<b>S-03012HDSBSLX4</b>	\$260.22

## BRAZED CORE BITS

PORCELAIN • CERAMIC • STONE



### PREMIUM GRADE

- Good for drilling cast iron and stainless steel sinks
- Works well wet or dry
- Approximate 35mm (1.37") drilling depth

**APPLICATIONS** - Porcelain Tile, Ceramic Tile, All Natural Stone, Engineered Stone, Stainless Steel Sinks

Size	Info	Part #	List Price
5mm (.20")	Straight Shank Porcelain Pin Drill, w/ oil	05SPB	\$72.35
6mm (.24")	Straight Shank Porcelain Pin Drill, w/ oil	06SPB	\$73.37
7mm (.28")	Straight Shank Porcelain Pin Drill, w/ oil	07SPB	\$74.84
8mm (.31")	Straight Shank Porcelain Pin Drill, w/ oil	08SPB	\$76.43
10mm (.39")	Straight Shank Porcelain Pin Drill, w/ oil	10SPB	\$84.60
12mm (.47")	Straight Shank Porcelain Pin Drill, w/ oil	12SPB	\$89.70
15mm (.59")	Straight Shank Porcelain Pin Drill, w/ oil	15SPB	\$98.77
20mm (.79") x 5/8"-11	Porcelain Pin Drill, no oil	20HPB	\$125.31
25mm (.98") x 5/8"-11	Porcelain Pin Drill, no oil	25HPB	\$127.35
30mm (1.18") x 5/8"-11	Porcelain Pin Drill, no oil	30HPB	\$137.55
35mm x 5/8"-11 (1.38")	Porcelain Pin Drill, no oil	35HPB	\$153.77

## ZENESIS™ Z-THIN WALL

NATURAL & ENGINEERED STONE



### ZENESIS™ GRADE

- 9.5mm (.374") segment height
- The new ZENESIS™ Z-Thin Wall Core Bit provides excellent performance on all natural and engineered stones. It's thin wall delivers fast cutting and its clever design minimizes chipping. It is equipped with wrench flats for easy installation.
- Thin wall provide fast cutting
- Designed to minimize chipping
- Approximate 35mm (1.37") drilling depth

**APPLICATIONS** - All Natural Stone, Engineered Stone, Porcelain

Size	Part #
3/4 x 5/8"-11	<b>S-00712HTWCBZ</b>
1 x 5/8"-11	<b>S-01012HTWCBZ</b>
1 1/8 x 5/8"-11	<b>S-01112HTWCBZ</b>
1 1/4 x 5/8"-11	<b>S-01212HTWCBZ</b>
1 3/8 x 5/8"-11	<b>S-01312HTWCBZ</b>
1 1/2 x 5/8"-11	<b>S-01512HTWCBZ</b>
1 3/4 x 5/8"-11	<b>S-01712HTWCBZ</b>

**THIN WALL CORE BITS**

ALL NATURAL STONE



**PREMIUM GRADE**

- 8.5mm (.335") segment height
- Leaves cleaner holes than dry segmented bits
- Works great on hard porcelain and sintered stone
- Approximate 35mm (1.37") drilling depth

**APPLICATIONS** - All Natural Stone, Tile

Size	Part #	List Price
3/4 x 5/8-11 (19mm)	<b>S-00712HTWCB</b>	\$119.41
1 x 5/8-11 (25mm)	<b>S-01012HTWCB</b>	\$125.87
1 1/8 x 5/8-11 (28mm)	S-01112HTWCB	\$129.62
1 1/4 x 5/8-11 (32mm)	<b>S-01212HTWCB</b>	\$134.27
1 3/8 x 5/8-11 (35mm)	<b>S-01312HTWCB</b>	\$140.73
1 1/2 x 5/8-11 (38mm)	<b>S-01512HTWCB</b>	\$146.29
1 3/4 x 5/8-11 (44mm)	<b>S-01712HTWCB</b>	\$162.05

Size	Part #	List Price
2 x 5/8-11 (51mm)	<b>S-02012HTWCB</b>	\$187.00
2 3/8 x 5/8-11 (60mm)	<b>S-02312HTWCB</b>	\$199.92
2 1/2 x 5/8-11 (67mm)	<b>S-02612HTWCB</b>	\$224.99
3 x 5/8-11 (75mm)	<b>S-03012HTWCB</b>	\$247.21
4 x 5/8-11 (100mm)	<b>S-04012HTWCB</b>	\$349.95
4 1/4 x 5/8-11 (120mm)	S-04712HTWCB	\$416.63

**THIN WALL CORE BITS**

ALL NATURAL STONE



**PREMIUM GRADE**

- 8.5mm (.335") segment height
- Specifically designed for CNC routers and saws that require 1/2 gas arbor
- Approximate 35mm (1.37") drilling depth

**APPLICATIONS** - All Natural Stone, Tile

Size	Part #	List Price
1 x 1/2 Gas (25mm)	S-01012GTWCB	\$125.87
1 1/4 x 1/2 Gas (32mm)	S-01212GTWCB	\$134.27
1 3/8 x 1/2 Gas (35mm)	<b>S-01312GTWCB</b>	\$140.73
1 1/2 x 1/2 Gas (38mm)	<b>S-01512GTWCB</b>	\$146.29
2 x 1/2 Gas (51mm)	S-02012GTWCB	\$187.00

**NON-CORING BITS**

ALL NATURAL STONE



**PREMIUM GRADE**

- 7mm (.275") segment height
- Approximate 77mm (3.03") drilling depth

**APPLICATIONS** - All Natural Stone

Size	Part #	List Price
3/16 x 5/8-11	NCB18	\$95.35
1/4 x 5/8-11	<b>NCB25</b>	\$100.11
3/8 x 5/8-11	<b>NCB37</b>	\$103.93
1/2 x 5/8-11	NCB50	\$123.95



**ZENESIS™ FINGER BITS**  
NATURAL & ENGINEERED STONE



CALL FOR PRICING

**ZENESIS™ GRADE**

- The all-new ZENESIS™ 4 and 7 segment Finger Bits provide top CNC performance on all stone materials. They deliver precise, quiet and chip-free cutting at faster speeds and can be used on soft to medium-hard materials (4 segments) or medium to hard materials (7 segments). The enhanced design utilizes our most advanced diamond pattern to date, which increases durability and prevents premature wear to ensure long tool life.
- 1/2" gas thread
- Cuts granite and engineered stone (without the full stop)
- Recommended RPM ranges from 4,200 in hard material to 5,500 in softer material with a feed rate of 12"~16" per minute

**APPLICATIONS** - Granite, Engineered Stone

Size	Part #
20mm x 1 1/8" x 1/2 Gas, 4 seg	S-02040FBZX4-4
22mm x 2 x 1/2 Gas, 4 seg	S-02250FBZX4-4
20mm x 1 1/8" x 1/2 Gas, 7 seg	S-02040FBZX4-7
22mm x 2 x 1/2 Gas, 7 seg	S-02250FBZX4-7

**FINGER BITS**  
ALL NATURAL STONE



**PREMIUM GRADE**

- 6 segments
- Designed for all natural and engineered stones
- 1/2 gas male arbor to for CNC routers and saws

**APPLICATIONS** - All Natural Stone

Size	Part #	List Price
22mm OD x 1 1/8" L x 1/2 Gas	<b>S-02241NWFB</b>	\$257.44
22mm OD x 2 L x 1/2 Gas	S-02251NWFB	\$262.69
25mm OD x 1 1/8" L x 1/2 Gas	S-02541NWFB	\$257.44
25mm OD x 2 L x 1/2 Gas	S-02551NWFB	\$286.05

**ROUTER BIT**  
ALL NATURAL STONE & TILE



**PREMIUM GRADE**

- Grinder router bits have a female 3/8" arbor that threads onto any grinder to profile marble, porcelain, block and granite. Each bit has 2 independent steel (not plastic) bearings so they can be run wet and dry. The shaping is done with high quality, large particulate diamonds that are brazed to the body of the bit. Top quality components equal top quality performance.

**APPLICATIONS** - All Natural Stone, Tile, Masonry

**AVAILABLE SHAPES**

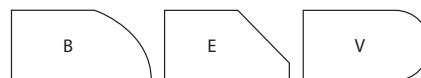

Size	Part #	List Price
3/4 Radius x 5/8-11	<b>S-20H3040RB-B</b>	\$667.44
3/8 Radius x 5/8-11	<b>S-10H3040RB-B</b>	\$514.88
25mm x 5/8-11	S-25H3040RB-B	\$645.65
30mm Bullnose x 5/8-11	<b>S-30H3040RB-V</b>	\$820.00
1/2" Bevel x 5/8-11	S-15H3040RB-E	\$558.46

**NEW**

**ZENESIS™ Z-FLEX PADS**

NATURAL & SINTERED STONE

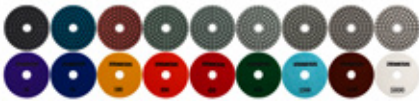
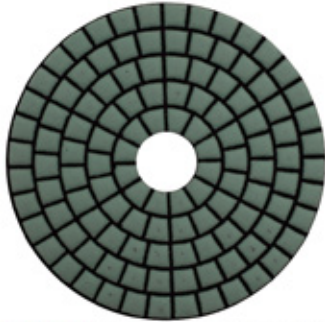

**ZENESIS™ GRADE**

- Discover ZENESIS™ Z-Flex Dry Ceramic Polishing Pads, revolutionizing stone polishing. Their unrivaled flexibility, powered by cutting-edge ceramic bond technology, redefines precision. Ideal for intricate edges like ogee, these pads elevate the polishing experience. With added grit options for exotic materials and restoration, they ensure impeccable results on natural stone, porcelain, and glass. Experience the evolution of polishing with ZENESIS™ Z-Flex Dry Pads, where flexibility meets flawless precision.

**APPLICATIONS** - Natural Stone, Porcelain, Quartzite, and Glass Tile

Size	Grit	Part #
4", Flexible Purple Velcro® Backing	30	S-4DPPHZ-30
4", Flexible Dark Blue Velcro® Backing	50	S-4DPPHZ-50
4", Flexible Yellow Velcro® Backing	100	S-4DPPHZ-100
4", Flexible orange Velcro® Backing	200	S-4DPPHZ-200
4", Flexible Red Velcro® Backing	400	S-4DPPHZ-400
4", Flexible Green Velcro® Backing	800	S-4DPPHZ-800
4", Flexible Light Blue Velcro® Backing	1500	S-4DPPHZ-1500
4", Flexible Brown Velcro® Backing	3000	S-4DPPHZ-3000
4", Flexible White Velcro® Backing	5000	S-4DPPHZ-5000
4", #30-5000 Grit, Pad set, Rigid Velcro® Backing	set	S-4DPPHZ-SET

**ZENESIS™ 3-STEP PADS**

NATURAL & ENGINEERED STONE

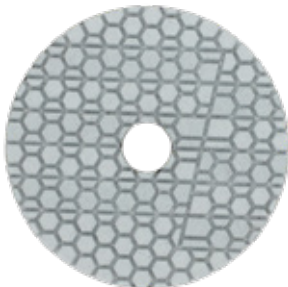

**ZENESIS™ GRADE**

- ZENESIS™ 3-Step Polishing Pads will save you time and make you money. Our pads give a spot on factory finish in half the time as traditional 7-step pads. The #1 pad sands the stone and takes out saw marks and light pitting; does the work of 50 to 200 grit. #2 pad hones the material taking out any swirl marks preparing the stone for polishing; does the work of 200 to 800 grit. #3 pad puts on an amazing high gloss polish; does the work of 800 to 3000 grit.
- Super high diamond concentration allows 1 pad to do the work of 3
- Special white resin will not stain your material
- Optional hyper aggressive position 0 can extend the life of #1 and #2

**APPLICATIONS** - All Natural Stone, Engineered Stone, Quartzite

Size	Part #
4 x 5/8" POS 0 Black Backing	<b>S-4WPPZW-3STEP-0</b>
4 x 5/8" POS 1 Blue Backing	<b>S-4WPPZW-3STEP-1</b>
4 x 5/8" POS 2 Yellow Backing	<b>S-4WPPZW-3STEP-2</b>
4 x 5/8" POS 3 Orange Backing	<b>S-4WPPZW-3STEP-3</b>

**ZENESIS™ WHITE RESIN PADS**

NATURAL & ENGINEERED STONE

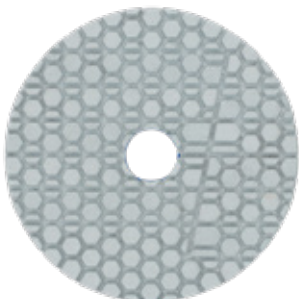
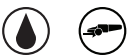

**ZENESIS™ GRADE**

- ZENESIS™ White Resin Polishing Pads are specially designed to deal with the challenges of engineered stone. Higher resin content in today's engineered stone present problems for traditional polishing pads. Standard pads can leave unacceptable swirl marks and scratches in your edge polish. Many colored pads can bleed and stain light colored Engineered Stones. The new ZENESIS™ pads specially formulated white resin will not scratch or stain even when brand new.
- These pads are made with a proprietary resin formula that works great on natural stone, and you won't believe what these pads can do on quartzite!

**APPLICATIONS** - All Natural Stone, Engineered Stone

Size	Part #	List Price
4 x 5/8" Blue Backing	50	<b>S-4WPPZW-7STEP-50</b>
4 x 5/8" Yellow Backing	100	<b>S-4WPPZW-7STEP-100</b>
4 x 5/8" Orange Backing	200	<b>S-4WPPZW-7STEP-200</b>
4 x 5/8" Red Backing	400	<b>S-4WPPZW-7STEP-400</b>
4 x 5/8" Green Backing	800	<b>S-4WPPZW-7STEP-800</b>
4 x 5/8" Light Blue Backing	1500	<b>S-4WPPZW-7STEP-1500</b>
4 x 5/8" Brown Backing	3000	<b>S-4WPPZW-7STEP-3000</b>

PART #'S IN BOLD INDICATE ROUTINELY STOCKED PRODUCTS

## ZENESIS™ PADS

NATURAL & ENGINEERED STONE



## ZENESIS™ GRADE

- ZENESIS™ Introduces an unmatched premium 7-Step Wet Polishing Pad. These new pads achieve the highest gloss readings after the 3000 grit level when polishing both white and black granite. Our unique design provides these pads with an exceptional lifespan.
- Removes dull spots, etches, and uneven surfaces quickly
- Shorter polishing times on the most difficult stone surfaces
- Better shine (higher gloss reading)

**APPLICATIONS** - All Natural Stone, Engineered Stone

Size	Part #	List Price
4 x 5/8"	50	S-4WPPZ-50
4 x 5/8"	100	S-4WPPZ-100
4 x 5/8"	200	S-4WPPZ-200
4 x 5/8"	400	S-4WPPZ-400
4 x 5/8"	800	S-4WPPZ-800
4 x 5/8"	1500	S-4WPPZ-1500
4 x 5/8"	3000	S-4WPPZ-3000

## PREMIUM PADS

NATURAL STONE



## PREMIUM GRADE

- Wet polishing pads, beehive type
- Designed for the fabricator who demands the best quality
- Unique honeycomb segments for the best water displacement while polishing
- Highest gloss finish
- 3mm thickness for long life
- Available in 4" and 5" diameter

**APPLICATIONS** - All Natural Stone

Size	Grit	Part #	List Price
4 x 5/8"	50	<b>S-4WPPX-50</b>	\$37.03
4 x 5/8"	100	<b>S-4WPPX-100</b>	\$37.03
4 x 5/8"	200	<b>S-4WPPX-200</b>	\$37.03
4 x 5/8"	400	<b>S-4WPPX-400</b>	\$37.03
4 x 5/8"	800	<b>S-4WPPX-800</b>	\$37.03
4 x 5/8"	1500	<b>S-4WPPX-1500</b>	\$37.03
4 x 5/8"	3000	<b>S-4WPPX-3000</b>	\$37.03
5 x 5/8"	50	<b>S-5WPPX-50</b>	\$50.92

Size	Grit	Part #	List Price
5 x 5/8"	100	<b>S-5WPPX-100</b>	\$50.92
5 x 5/8"	200	<b>S-5WPPX-200</b>	\$50.92
5 x 5/8"	400	<b>S-5WPPX-400</b>	\$50.92
5 x 5/8"	800	<b>S-5WPPX-800</b>	\$50.92
5 x 5/8"	1500	<b>S-5WPPX-1500</b>	\$50.92
5 x 5/8"	3000	<b>S-5WPPX-3000</b>	\$50.92
4 x 5/8"	50-3000 + Backer Pad	S-4WPPX-SET	\$326.59

## HEXAGON PADS

NATURAL STONE

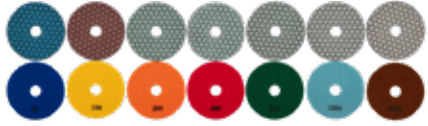
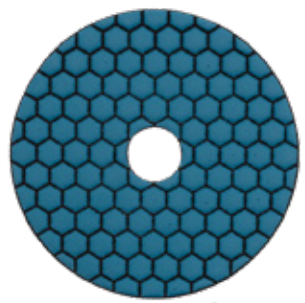

## PREMIUM GRADE

- Dry polishing pads, hexagon type
- These ceramic pads leave an amazing finish dry or wet
- Available in complete set with backer pad and case

**APPLICATIONS** - All Natural Stone, Glass Tile

Size	Grit	Part #	List Price
4 x 5/8"	50	<b>S-4DPPH50</b>	\$32.43
4 x 5/8"	100	<b>S-4DPPH100</b>	\$32.43
4 x 5/8"	200	<b>S-4DPPH200</b>	\$32.43
4 x 5/8"	400	<b>S-4DPPH400</b>	\$32.43
4 x 5/8"	800	<b>S-4DPPH800</b>	\$32.43
4 x 5/8"	1500	<b>S-4DPPH1500</b>	\$32.43
4 x 5/8"	3000	<b>S-4DPPH3000</b>	\$32.43
5 x 5/8"	50	S-5DPPH50	\$55.54

Size	Grit	Part #	List Price
5 x 5/8"	100	S-5DPPH100	\$55.54
5 x 5/8"	200	S-5DPPH200	\$55.54
5 x 5/8"	400	S-5DPPH400	\$55.54
5 x 5/8"	800	S-5DPPH800	\$55.54
5 x 5/8"	1500	S-5DPPH1500	\$55.54
5 x 5/8"	3000	S-5DPPH3000	\$55.54
4 x 5/8"	50-3000 + backer pad	S-4DPPH-SET	\$291.60



**WHITE RESIN PADS**

GENERAL PURPOSE

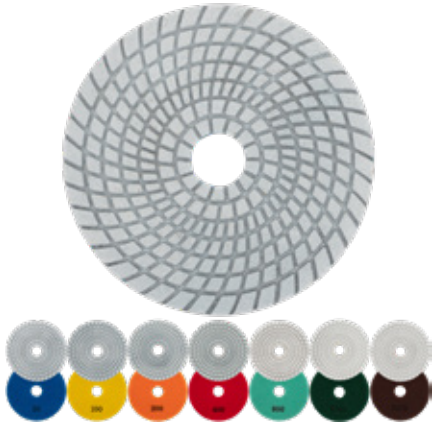

**PREMIUM GRADE**

- These soft resin pads are best for engineered stones with high resin content
- No break in required
- Gives perfect polish on engineered stone, natural stone, and even glass
- Engineered stones must be run wet to prevent material burn

**APPLICATIONS** - For edge and surface polishing, Engineered Stone, Natural Stone, Glass

Size	Grit	Part #	List Price
4 x 5/8"	50	S-4WPPER-50	\$21.81
4 x 5/8"	100	S-4WPPER-100	\$21.81
4 x 5/8"	200	S-4WPPER-200	\$21.81
4 x 5/8"	400	S-4WPPER-400	\$21.81
4 x 5/8"	800	S-4WPPER-800	\$21.81
4 x 5/8"	1500	S-4WPPER-1500	\$21.81
4 x 5/8"	3000	S-4WPPER-3000	\$21.81

**STANDARD PADS**

NATURAL STONE



**VALUE GRADE**

- Wet polishing pads, square type
- This 3mm thick pad is our most popular pad
- Available in 3", 4" and 5" diameter
- Excellent for granite, engineered stone, and concrete

**APPLICATIONS** - All Natural Stone

Size	Grit	Part #	List Price
3 x 5/8"	50	S-3WPP-50	\$19.96
3 x 5/8"	100	S-3WPP-100	\$19.96
3 x 5/8"	200	S-3WPP-200	\$19.96
3 x 5/8"	400	S-3WPP-400	\$19.96
3 x 5/8"	800	S-3WPP-800	\$19.96
3 x 5/8"	1500	S-3WPP-1500	\$19.96
3 x 5/8"	3000	S-3WPP-3000	\$19.96
4 x 5/8"	50	<b>S-4WPP-50</b>	\$26.94
4 x 5/8"	100	<b>S-4WPP-100</b>	\$26.94
4 x 5/8"	200	<b>S-4WPP-200</b>	\$26.94
4 x 5/8"	400	<b>S-4WPP-400</b>	\$26.94
4 x 5/8"	800	<b>S-4WPP-800</b>	\$26.94
4 x 5/8"	1500	<b>S-4WPP-1500</b>	\$26.94

Size	Grit	Part #	List Price
4 x 5/8"	3000	<b>S-4WPP-3000</b>	\$26.94
5 x 5/8"	50	<b>S-5WPP-50</b>	\$35.03
5 x 5/8"	100	<b>S-5WPP-100</b>	\$35.03
5 x 5/8"	200	<b>S-5WPP-200</b>	\$35.03
5 x 5/8"	400	<b>S-5WPP-400</b>	\$35.03
5 x 5/8"	800	<b>S-5WPP-800</b>	\$35.03
5 x 5/8"	1500	<b>S-5WPP-1500</b>	\$35.03
5 x 5/8"	3000	<b>S-5WPP-3000</b>	\$35.03
4 x 5/8"	50-3000 + Backer Pad	S-4WPP-SET	\$233.28

**ELECTROPLATED PADS**

CONCRETE & MARBLE

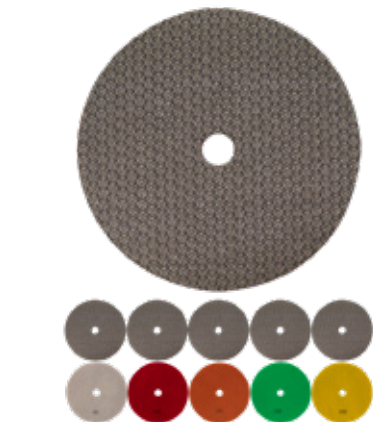

**PREMIUM GRADE**

- Premium grade diamonds electroplated to Velcro® back pad
- These flexible diamond discs are basically diamond sandpaper. Since they are raw diamond electroplated to foil disc they can be used to shape, sand and hone any natural stone or tile. The larger 7" and 9" discs are popular for sanding interior pool finishes.
- Great for sanding marble, concrete counter tops, and swimming pool interiors
- Available in 5", 7" and 9" diameter
- Grits over 400 available upon request

**APPLICATIONS** - Marble, Concrete Counter tops, Swimming Pool Interiors

Size	Grit	Part #	List Price
5"	60	S-05BEPSP2-60	\$74.24
5"	100	S-05BEPSP2-100	\$74.24
5"	150	S-05BEPSP2-150	\$74.24
5"	200	S-05BEPSP2-200	\$74.24
5"	400	S-05BEPSP2-400	\$74.24
5"	600	S-05BEPSP2-600	\$74.24
7"	60	S-07BEPSP2-60	\$177.09
7"	100	S-07BEPSP2-100	\$177.09
7"	150	S-07BEPSP2-150	\$177.09

Size	Grit	Part #	List Price
7"	200	S-07BEPSP2-200	\$177.09
7"	400	S-07BEPSP2-400	\$177.09
7"	600	S-07BEPSP2-600	\$177.09
9"	60	S-09BEPSP2-60	\$299.93
9"	100	S-09BEPSP2-100	\$299.93
9"	150	S-09BEPSP2-150	\$299.93
9"	200	S-09BEPSP2-200	\$299.93
9"	400	S-09BEPSP2-400	\$299.93
9"	600	S-09BEPSP2-600	\$299.93



## RESIN MATRIX PADS

### NATURAL STONE

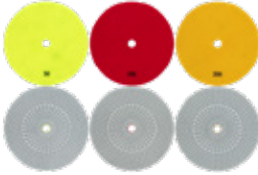
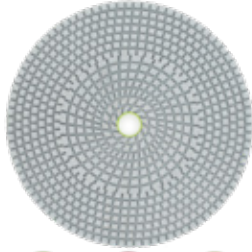

### PREMIUM GRADE

- These 7" pads are the first resin pad made specifically for the hardscape industry
- 3mm thick resin for long life
- Premium grade materials for fast removal
- Non colored resin leaves no stains or bleeding into plaster

**APPLICATIONS** - Porcelain, All Natural Stone

Size	Grit	Part #	List Price
7 x 7/8"	50	<b>S-7WRP-50</b>	\$152.56
7 x 7/8"	100	<b>S-7WRP-100</b>	\$152.56
7 x 7/8"	200	<b>S-7WRP-200</b>	\$152.56

## HYBRID 3-STEP PADS

### NATURAL STONE

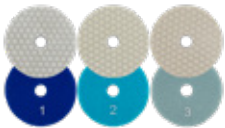

### PREMIUM GRADE

- Replacing 7-step polishing with only 3 pads
- #1 pad sand the material, removing saw and grinding marks. Perfect for tumbled travertine
- #2 pad hones the material giving it a semi-gloss look and super smooth finish
- #3 pad polishes the material giving it a full gloss shine quickly
- Great for back-splashes and sink openings
- Amazing for giving porcelain a finished edge detail

**APPLICATIONS** - All Natural Stone

Size	Part #	List Price
4 x 7/8", POS 1	<b>S-4DP-P1</b>	\$22.92
4 x 7/8", POS 2	<b>S-4DP-P2</b>	\$22.92
4 x 7/8", POS 3	<b>S-4DP-P3</b>	\$22.92
4 x 7/8"	<b>S-4DP-3STEP</b>	\$68.77

## BACKING PADS

### NATURAL STONE

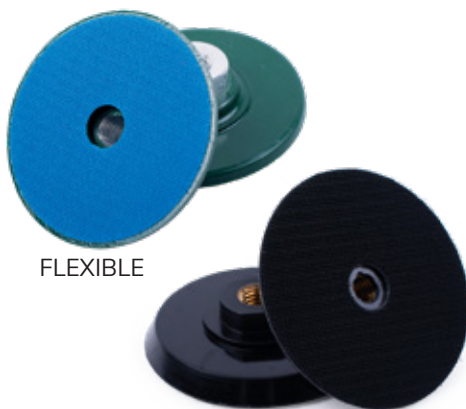

FLEXIBLE

RIGID

### FLEXIBLE PADS

- For attaching Velcro® backed polishing pads
- 7/8"-11 threading
- Flex type

**APPLICATIONS** - All Natural Stone

Size	Part #	List Price
3 x 7/8"-11	<b>S-3BP</b>	\$23.13
4 x 7/8"-11	<b>S-4BP</b>	\$30.50
5 x 7/8"-11	<b>S-5BP</b>	\$37.08
7 x 7/8"-11	<b>S-7BP</b>	\$114.20

### RIGID PADS

- For attaching Velcro® backed polishing pads
- Rigid type

**APPLICATIONS** - All Natural Stone

Size	Part #	List Price
4 x 7/8"-11	<b>S-4BPR</b>	\$36.11
5 x 7/8"-11	<b>S-5BPR</b>	\$39.80

**6-STEP SYSTEM**

NATURAL & ENGINEERED STONE



**PREMIUM GRADE**

- Designed for radius polishing on machines that require 4" snail lock backed tools
- Position 1 - Coarse metal bond for shaping material with a Snail lock back
- Position 2 - Medium metal bond to prepare material for polishing with a Snail lock back
- Position 3 - Coarse resin bond to sand the material with a Velcro® back
- Position 4 - Medium resin bond to hone the material with Velcro® back
- Position 5 - Fine resin bond to polish the material with Velcro® back
- Position 6 - Buff resin bond for darker materials with Velcro® back

**APPLICATIONS** - Radius polishing on All Natural Stone, Engineered Stone

Size	Part #	List Price
4" x SNAIL LOCK, POS 1 (COARSE)	S-4AEGC01	\$448.13
4" x SNAIL LOCK, POS 2 (MEDIUM)	S-4AEGM02	\$448.13
4" x Velcro®, RESIN, 3	S-4AEGR03	\$61.97
4" x Velcro®, RESIN, 4	S-4AEGR04	\$61.97
4" x Velcro®, RESIN, 5	S-4AEGR05	\$61.97
4" x Velcro®, RESIN, 6	S-4AEGR06	\$61.97

**HYBRID FLAT SNAIL LOCK**

NATURAL & ENGINEERED STONE



- These pads are specifically designed for flat polishing with machines that require 4" snail lock tools
- Unique honeycomb design gives perfect water displacement
- The 50, 100, 200, and 400 grits are made with a hybrid copper bond that gives long life and speed
- The 800, 1500, and 3000 leave a mirror finish

**APPLICATIONS** - Flat polishing on All Natural Stone, Engineered Stone

Size	Part #	List Price
4 x .315 x SNAIL LOCK	S-4WRCS-50	\$125.32
4 x .315 x SNAIL LOCK	S-4WRCS-100	\$125.32
4 x .315 x SNAIL LOCK	S-4WRCS-200	\$125.32
4 x .315 x SNAIL LOCK	S-4WRCS-400	\$125.32
4 x .315 x SNAIL LOCK	S-4WRRS-800	\$125.32
4 x .315 x SNAIL LOCK	S-4WRRS-1500	\$125.32
4 x .315 x SNAIL LOCK	S-4WRRS-3000	\$125.32

**IN-LINE PADS**

NATURAL & ENGINEERED STONE



- 5" and 6" snail lock backed pads for flat polishing of engineered and natural stone on automated polishing machines
- Soft bond requires minimum pressure to achieve perfect shine
- White resin will not bleed or stain stone
- Polishes all engineered stones in a single pass, light or dark
- Unique resin pattern evenly distributes water to prevent burning
- Extra thick pad gives very long life

**APPLICATIONS** - All Natural Stone, Engineered Stone

Size	Grit	Part #	List Price
5	50	S-5WRPS-50	\$74.27
5	100	S-5WRPS-100	\$74.27
5	200	S-5WRPS-200	\$74.27
5	400	S-5WRPS-400	\$74.27
5	800	S-5WRPS-800	\$74.27
5	1500	S-5WRPS-1500	\$74.27
5	3000	S-5WRPS-3000	\$74.27

Size	Grit	Part #	List Price
6	50	S-6WRPS-50	\$94.27
6	100	S-6WRPS-100	\$94.27
6	200	S-6WRPS-200	\$94.27
6	400	S-6WRPS-400	\$94.27
6	800	S-6WRPS-800	\$94.27
6	1500	S-6WRPS-1500	\$94.27
6	3000	S-6WRPS-3000	\$94.27

## ZENESIS™ RESIN CUP WHEELS

NATURAL & ENGINEERED STONE



## BLUE CUP WHEEL

NATURAL & ENGINEERED STONE



## ANTIQUING BRUSHES

NATURAL STONE



### ZENESIS™ GRADE

- Very highest quality diamonds, metals and resin outperforms all competition
- Unique segment and resin design filled for continuous surface
- Each cup is precision balanced to eliminate vibration and chipping
- Available in coarse, medium and fine
- Eliminates need for dangerous silicon carbide wheels
- Best cup wheel for flat grinding

**APPLICATIONS** - All Natural and Engineered Stone

Size	Part #
4 x 5/8-11, fine 120/140 grit	<b>S-04FWRIGGZX4-2</b>
4 x 5/8-11, medium 80/100 grit	<b>S-04MWRIGGZX4-2</b>
4 x 5/8-11, coarse 50/60 grit	<b>S-04CWRIGGZX4-2</b>



### PREMIUM GRADE

- Special turbo design for a fast and smooth finish
- Coarse grit for the most aggressive (fastest) grinding
- Medium grit for a combination of both speed and finish
- Each wheel is precision balanced to minimize chipping
- Fine grit for the smoothest finish

**APPLICATIONS** - Granite, All Natural Stone, Engineered Stone

Size	Grit	Part #	List Price
4 x 5/8-11	coarse grit	<b>S-04HDZGX3-C</b>	\$152.55
4 x 5/8-11	fine grit	<b>S-04HDZGX3-F</b>	\$152.55
4 x 5/8-11	medium grit	<b>S-04HDZGX3-M</b>	\$152.55
5 x 5/8-11	coarse grit	<b>S-05HDZGX3-C</b>	\$228.82
5 x 5/8-11	fine grit	<b>S-05HDZGX3-F</b>	\$228.82
5 x 5/8-11	medium grit	<b>S-05HDZGX3-M</b>	\$228.82
6 x 5/8-11	coarse grit	<b>S-06HDZGX3-C</b>	\$271.80
6 x 5/8-11	fine grit	S-06HDZGX3-F	\$271.80
6 x 5/8-11	medium grit	S-06HDZGX3-M	\$271.80
7 x 5/8-11	coarse grit	<b>S-07HDZGX3-C</b>	\$328.92
7 x 5/8-11	medium grit	<b>S-07HDZGX3-M</b>	\$328.92

- Diamond and Nylon wire brushes for creating leather finishes on natural stone
- Leathering brushes create a distressed 3 dimensional finish that is becoming more popular every day
- The leathering process uses several grits to erode the stone taking down the softer parts and leaving the harder parts higher
- As you progress from the coarse brushes to the finer the color and texture get deeper and richer
- Highest quality and professional grade
- Comes with 5/8-11 and Snail Lock threads

**APPLICATIONS** - All Natural Stone

Size	Grit	Part #	List Price
4	24	<b>S-4ABG-24</b>	\$106.24
4	36	<b>S-4ABG-36</b>	\$106.24
4	46	<b>S-4ABG-46</b>	\$106.24
4	60	<b>S-4ABG-60</b>	\$106.24
4	80	<b>S-4ABG-80</b>	\$106.24
4	120	<b>S-4ABG-120</b>	\$106.24
4	180	<b>S-4ABG-180</b>	\$106.24
4	240	<b>S-4ABG-240</b>	\$106.24
4	320	<b>S-4ABG-320</b>	\$106.24

Size	Grit	Part #	List Price
4	400	<b>S-4ABG-400</b>	\$106.24
4	500	<b>S-4ABG-500</b>	\$106.24
4	600	S-4ABG-600	\$106.24
4	800	<b>S-4ABG-800</b>	\$106.24
4	1000	S-4ABG-1000	\$106.24
4	1200	S-4ABG-1200	\$106.24
4	1500	S-4ABG-1500	\$106.24
4	1800	S-4ABG-1800	\$106.24
4	2000	S-4ABG-2000	\$106.24

**ZENESIS™ ZERO TOLERANCE WHEEL**

NATURAL & ENGINEERED STONE



ZENESIS™ GRADE

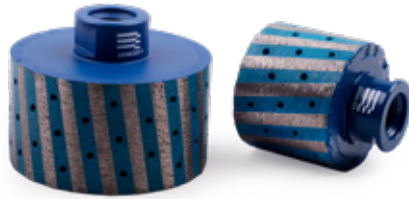

CALL FOR PRICING

- The ZENESIS™ Zero Tolerance Wheel feature resin-filled metal segments for fast grinding with reduced vibration. Since they use ZENESIS™ Patterned Technology, the tool life is long and the finish exceptionally smooth.
- 5/8"-11 thread
- Can be used wet or dry

**APPLICATIONS** - Granite, Engineered Stone

Size	Part #
2 x 1 1/2"	<b>S-2158ZTWZX4</b>
3 x 1 1/2"	S-3158ZTWZX4

**ZERO TOLERANCE WHEEL**

NATURAL STONE



**PREMIUM GRADE**

- Designed for grinding on vertical surfaces like sink openings
- Resin filled segments for smooth finish
- Great on any natural stone, masonry and concrete
- Available in 2", 3" and 4" diameter

**APPLICATIONS** - All Natural Stone

SEGMENTED

Size	Part #	List Price
2 x 1 1/2" L x 5/8"-11	S-02158HZZ-S	\$247.90
3 x 1 1/2" L x 5/8"-11	S-03158HZZ-S	\$300.34
4 x 1 1/2" L x 5/8"-11	S-04158HZZ-S	\$357.55

RESIN FILLED

Size	Part #	List Price
2 x 1 1/2" L x 5/8"-11	S-02158HZZ-R	\$295.58
3 x 1 1/2" L x 5/8"-11	S-03158HZZ-R	\$352.79
4 x 1 1/2" L x 5/8"-11	S-04158HZZ-R	\$410.00

**SHAPING TOOLS**

STONE & CONCRETE



**PREMIUM GRADE**

- Shank size: 5.95mm (.23") diameter, 45mm (1.77") length
- Designed to be used where diamond blades and cup wheels can't
- 1/4" shank to fit any tool with 1/4" collet like die grinders and trim routers
- Extremely popular with stone sculptors

**APPLICATIONS** - Different shapes available for natural stones and concrete.

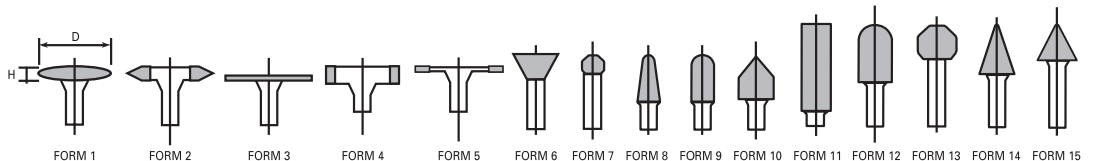

Form	Dia. (mm)	H. (mm)	Part #	List Price
FORM 1	25	5	S-ST01	\$81.06
FORM 2	30	5	S-ST02	\$81.06
FORM 3	30	1.9	S-ST03	\$81.06
FORM 4	25	6	S-ST04	\$81.06
FORM 5	30	1.8	S-ST05	\$81.06

Form	Dia. (mm)	H. (mm)	Part #	List Price
FORM 6	16	8.7	S-ST06	\$81.06
FORM 7	8	6.6	S-ST07	\$81.06
FORM 8	8	16	<b>S-ST08</b>	\$81.06
FORM 9	8	16	S-ST09	\$81.06
FORM 10	12.5	15	S-ST10	\$81.06

Form	Dia. (mm)	H. (mm)	Part #	List Price
FORM 11	10	30	<b>S-ST11</b>	\$81.06
FORM 12	12	20	S-ST12	\$81.06
FORM 13	13	12.2	S-ST13	\$81.06
FORM 14	12	17	S-ST14	\$81.06
FORM 15	14	12	S-ST15	\$81.06

PART #'S IN BOLD INDICATE ROUTINELY STOCKED PRODUCTS





# DIAMOND<sup>®</sup> METAL CUTTING

## HIGH PERFORMANCE & COST EFFICIENCY

### Long Tool Life and Less Down Time

Diamond<sup>®</sup> saves you money by providing extended tool life as well as dramatically reducing downtime caused by changing out worn abrasives.

## SAFETY

### Reduced Vibration and Less Wheel Breakage

Traditional bonded abrasives are susceptible to fracture and breakage. If this occurs, it can cause injury and becomes a serious safety concern. Diamond<sup>®</sup> improved technology of brazing diamond grits to the surface of a solid steel body greatly reduces the risk of fracture and breakage.

## WHEEL WEAR

### Retains Tool Size and Shape

The disadvantages of traditional bonded abrasives are short tool life and continuously changing tool size and shape during usage. Diamond<sup>®</sup> offers extended tool life, and its size and shape does not change throughout its tool life.

## APPLICATION

### Variety and Versatility

Diamond<sup>®</sup> offers a wide variety of tools for cutting, grinding, weld joint removal, forming, and surface prep work. And because Diamond<sup>®</sup> tools are exceptionally versatile, they can be used on ferrous and non-ferrous metals as well as ceramics and polymers.

## ENVIRONMENTALLY & OPERATOR FRIENDLY

### Reduced Sparks, Less Debris and Minimal Odor

Traditional abrasives produce a high volume of sparks and odor as well as debris as the abrasives wear down. With Diamond<sup>®</sup>, sparks are greatly reduced, odor is minimal, and the only debris remaining is from the material being worked.

### Reduced Sparks

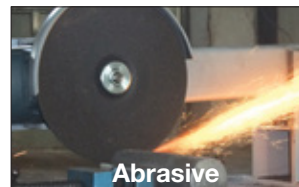

### Less Debris

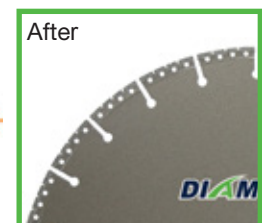
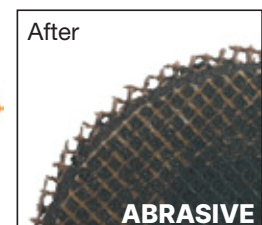

**CHOPPER**  
FOR CHOP SAW



- The all-new Diamond<sup>®</sup> Chopper is a metal cutting chop saw blade. Designed for use on low-powered metal cutting chop saws, the 14" Diamond<sup>®</sup> Chopper will chop through steel, stainless steel, rebar, structural steel and bolts with ease. The 14" Diamond<sup>®</sup> Chopper will make more cuts than up to 70 conventional abrasive wheels\*, greatly increasing the productivity by reducing the downtime associated with changing out worn abrasives.
- Like all Diamond<sup>®</sup> products, the new 14" Diamond<sup>®</sup> Chopper is much safer and more eco-friendly than abrasives. The tools are made of steel and diamonds, which retain their shape, cut after cut. The steel core is virtually indestructible, providing a much safer working environment when compared to conventional abrasives that can fracture & break. Sparks, odor and debris are all greatly reduced, improving working conditions for the operator.
- \*1, 14" Diamond<sup>®</sup> Chopper will outlast up to 70, 14" abrasive discs. Results may vary depending on the application, machine, and operator.

**APPLICATIONS** - Steel, Stainless Steel, Rebar, Studs, Bolts, Pipe, Sectional Tubing

Size	Part #	List Price
14 x .134 x 1/20mm	<b>DXC0120P1413E</b>	\$343.26

**CUTTER**  
HIGH SPEED



- The all-new 14" Diamond<sup>®</sup> Cutter is the most advanced, versatile and powerful Diamond<sup>®</sup> blade we've ever created. We've made advancements to our brazing technology to increase the speed and longevity of the blade. The higher quality diamonds are bonded to the steel core with a level of precision that is simply unmatched in the industry. Designed for use on high speed gasoline cutoff saws and higher-powered chop saws, the 14" Diamond<sup>®</sup> Cutter will slice through steel, stainless steel, rebar, structural steel and bolts with ease. The 14" Diamond<sup>®</sup> Cutter will make more cuts than up to 70 conventional abrasive wheels\*, greatly increasing the productivity by reducing the downtime associated with changing out worn abrasives.
- Like all Diamond<sup>®</sup> products, the new 14" Diamond<sup>®</sup> Cutter is much safer and more eco-friendly than abrasives. The tools are made of steel and diamonds, which retain their shape, cut after cut. The steel core is virtually indestructible, providing a much safer working environment when compared to conventional abrasives that can fracture & break. Sparks, odor and debris are all greatly reduced, improving working conditions for the operator.
- For use only on a high speed gas saw

**APPLICATIONS** - Steel, Stainless Steel, Bolts, Nonferrous materials, Plastics, Fiberglass, Wood, Concrete, Tile, Brick

Size	Part #	List Price
14 x .150 x 1/20mm	<b>DXH0120P1415E</b>	\$487.22

**CUTTER**  
SMALL DIAMETER



**APPLICATIONS** - Steel, Stainless Steel, Bolts, Nonferrous materials, Plastics, Fiberglass, Wood, Concrete, Tile, Brick

Size	Part #	List Price
2 x .050 x 3/8-1/4	<b>DXE0130P02053</b>	\$29.03
3 x .050 x 3/8-1/4	<b>DXE0130P03053</b>	\$31.43
4 x .050 x 3/8	<b>DXE0130P0405A</b>	\$40.86
4 1/2 x .050 x 7/8	<b>DXE0130P4505C</b>	\$44.70
5 x .050 x 7/8	<b>DXE0130P0505C</b>	\$55.38
6 x .050 x 7/8	<b>DXE0130P0605C</b>	\$64.82
7 x .060 x U/A	<b>DXE0130P0706U</b>	\$92.71
9 x .060 x 7/8	<b>DXE0130P0906C</b>	\$158.35

**TYPE 29**

DEPRESSED CENTER GRINDING DISC



**APPLICATIONS** -Weld removal, pipe beveling, and stock removal of all ferrous and non-ferrous metals including mild steel, stainless steel, alloy steels, ductile materials, hard-face metal alloys and ceramic

Size	Grit Size	Part #	List Price
4 x 5/8	24	<b>DXA2920P04A</b>	\$105.51
4½ x 5/8-11	24	<b>DXA2920P45H</b>	\$112.54
5 x 5/8-11	24	<b>DXA2920P05H</b>	\$152.06
6 x 5/8-11	24	<b>DXA2920P06H</b>	\$175.82
7 x 5/8-11	24	<b>DXA2920P07H</b>	\$224.77
9 x 5/8-11	24	DXA2920P09H	\$282.20

**TYPE 29 FINER FINISH**

DEPRESSED CENTER GRINDING DISC



**APPLICATIONS** - Weld removal. Finer finish for wide variety of applications

Size	Grit Size	Part #	List Price
4 x 5/8	50	DXA2930P04A	\$105.51
4½ x 5/8-11	50	<b>DXA2930P45H</b>	\$112.54
5 x 5/8-11	50	DXA2930P05H	\$152.06
6 x 5/8-11	50	DXA2930P06H	\$175.82
7 x 5/8-11	50	DXA2930P07H	\$224.77
9 x 5/8-11	50	DXA2930P09H	\$282.20

**TYPE 27**

PIPELINE DISC



**APPLICATIONS** - All pipeline applications

Size	Grit Size	Part #	List Price
4 x .156 x 5/8	50	DXA2730P04A	\$180.23
4½ x .156 x 5/8-11	50	DXA2730P45H	\$190.27
5 x .156 x 5/8-11	50	DXA2730P05H	\$206.50
6 x .156 x 5/8-11	50	DXA2730P06H	\$287.80
7 x .156 x 5/8-11	50	DXA2730P07H	\$387.90
9 x .156 x 5/8-11	50	DXA2730P09H	\$514.39



## TYPE 27

### FOUNDRY DISC



**APPLICATIONS** - All ferrous and non-ferrous materials

Size	Grit Size	Part #	List Price
7 x .140 x 5/8-11	36	DXA2725P07H	\$514.28
9 x .140 x 5/8-11	36	DXA2725P09H	\$747.26

## TYPE 1

### CUTTING & GRINDING WHEEL



**APPLICATIONS** - Foundry-gate/rise removal, forgings, metal pipe, sectional tubing, metal plate, steel bar and ductile iron

Size	Grit Size	Part #	List Price
4 x .137 x 5/8	36	<b>DXB0125P0414A</b>	\$117.62
4½ x .137 x 5/8	36	<b>DXB0125P4514C</b>	\$127.67
5 x .137 x 7/8	36	DXB0125P0514C	\$162.71
6 x .137 x 7/8	36	DXB0125P0614C	\$175.20
7 x .137 x 7/8	36	DXB0125P0714C	\$212.69
9 x .137 x 7/8	36	DXB0125P0914C	\$317.81

## TYPE 1

### REVERSIBLE HARD FACE GRINDING WHEEL



**APPLICATIONS** - Weld removal, pipe beveling, and stock removal of all ferrous and non-ferrous metals including mild steel, stainless steel, alloy steels, ductile materials, hard-face metal alloys and ceramic

Size	Grit Size	Part #	List Price
4 x .250 x 5/8	36	DXA0125P0425A	\$176.48
4½ x .250 x 5/8-11	36	<b>DXA0125P4525H</b>	\$194.00
5 x .250 x 5/8-11	36	DXA0125P0525H	\$217.72
6 x .250 x 5/8-11	36	DXA0125P0625H	\$265.25
7 x .250 x 5/8-11	36	DXA0125P0725H	\$315.37
9 x .250 x 5/8-11	36	DXA0125P0925H	\$409.27



## TYPE 1 CUTTING WHEEL



**APPLICATIONS** - Foundry-gate/rise removal, forgings, sheet metal, pipe, metal plate, round & sectional tubing, steel bar, angle iron, cast iron, ductile iron, metal studs and carbon/mild steel

Size	Grit Size	Part #	List Price
16 x .155 x 1	24	<b>DXE0120P1615E</b>	\$379.09
18 x .155 x 1	24	DXE0120P1815E	\$583.73
20 x .170 x 1	24	<b>DXE0120P2017E</b>	\$693.63
24 x .185 x 1	24	DXE0120P2418E	\$1,328.61
26 x .185 x 1	24	DXE0120P2618E	\$1,687.73
28 x .200 x 1	24	DXE0120P2820E	\$2,143.81
30 x .200 x 1	24	DXE0120P3020E	\$2,320.89

To learn more about  
DIAMOND<sup>®</sup> products,  
download the catalog!





# EQUIPMENT

## MDE350 MASONRY SAW

- The MDE350 Dry Masonry Saw features a powerful 3HP motor and 14" blade capacity for fast cutting of brick/block and general purpose applications. The saw can also be used wet with our optional wet kit. The powerful dust collector kit (optional) ensures clean cutting, indoors or out.
- Stand Part #: MDE350-ST

Blade Capacity	14"
Weight	75 lbs
Horse Power	3HP
Arbor Size	1"
RPM	3,600
Max Cut Depth	5"
Rip Cutting	16"
Thermal Protection	Equipped
Motor	115V/60Hz





# GS300 SELF-PROPELLED EARLY ENTRY SAW

GorillaConcreteTools



- Patent Pending High-Efficiency Dust Box with Blade Sight Window
- Centered Lifting Hook
- Linkage Controlled Front Pointer Arm
- Quick Blade Depth Adjustment
- Ergonomic Handle
- Integrated Wrench Holder

Blade Capacity	10"
Weight	305 lbs
Arbor Size	7/8"
Cutting Depth	Up to 3 inches
Drive	High Torque Electric Drive with Variable Speed
Vacuum Requirements	250 CFM with 2" Dust Port
Motor	Honda GX390 (11.7 HP)
Engine Start	Recoil

# GS100 GREEN CONCRETE EARLY ENTRY SAW

GorillaConcreteTools



- Patent Pending High-Efficiency Dust Box with Blade Sight Window
- Front and Rear Pointers for Cut Accuracy
- Lightweight for easy Loading & Unloading
- Ergonomic Handle
- Integrated Wrench Holder
- Great for Same Day or Next Day Cutting

Blade Capacity	8"
Weight	108lbs
Arbor Size	7/8"
Cutting Depth	Up to 2"
Frame Construction	Powder Coated Steel
Vacuum Requirements	250 CFM with 2" Dust Port
Motor	Honda GX200 (5.5HP)

# 8EE GREEN CONCRETE EARLY ENTRY SAW

GorillaConcreteTools



All Terrain Wheel Kit  
(sold separately)



- Patent Pending High-Efficiency Dust Box with Blade Sight Window
- Quick blade depth adjustment
- 3-position handle
- Integrated Wrench Holder
- Great for Same Day or Next Day Cutting
- Front and Rear Blade Pointers
- Green Skid Plate to Reduce Chipping
- All Terrain Wheel Kit part # DV-GCT-8-AWK-1

Blade Capacity	8"
Weight	140lbs
Arbor Size	7/8"
Cutting Depth	Up to 2"
Frame Construction	Powder Coated Steel
Vacuum Requirements	250 CFM with 2" Dust Port
Motor	Honda GX200 (5.5 HP) or Kohler CH270 (7 HP)



# HAKKEN DRILLS

The **BEST** drilling tools package starts here

**Hakken**  
Japanese Technology



## SMD08

- Motor comes with slip clutch that can be easily adjusted from outside the motor and can be completed on the job site
- Max core bit length of 21" can be installed
- Feed handle can be placed on either right or left side of carriage for easy drilling close to walls and columns
- 4 adjustable leveling screws for drilling uneven surfaces
- Double insulated construction
- Swiveling water valve can be rotated full 360 degrees for added convenience
- Engineered for both vertical & horizontal drilling
- One-year limited warranty

## SPECIFICATIONS

Power	120V
Rated Current	15A
Max Output	2.4kw (3.2HP)
Max Bit Capacity	8"
Spindle Thread	1-1/4"-7
Column Thickness	1-15/16"
Stand Height	31-7/8"
Carriage Travel	19-7/8"
Anchor Base	7" x 8.5" (WxL)
Clutch Type	Slip
Speed	700 RPM (No Load)
Weight	41 lbs. (18.5 kg)



## SMD12

- Motor comes with slip clutch that can be easily adjusted from outside the motor and can be completed on the job site
- Max core bit length of 26" can be installed
- Feed handle can be placed on either right or left side of carriage for easy drilling close to walls and columns
- 4 adjustable leveling screws for drilling uneven surfaces
- Double insulated construction
- Swiveling water valve can be rotated full 360 degrees for added convenience
- Engineered for both vertical & horizontal drilling
- One-year limited warranty

## SPECIFICATIONS

Power	120V
Rated Current	20A
Max Output	2.4kw (3.2HP)
Max Bit Capacity	12"
Spindle Thread	1-1/4"-7
Column Thickness	2-5/16"
Stand Height	39-3/8"
Carriage Travel	24-3/8"
Anchor Base	7.5" x 10" (WxL)
Clutch Type	Slip
Speed	400/950 RPM (No Load)
Weight	63 lbs. (28.4 kg)

## ADDITIONAL ACCESSORIES

### STANDARD STAND

Lightweight standard pole base

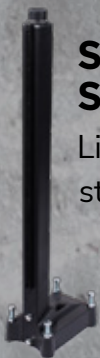

### STANDARD WITH LARGE VACUUM BASE

Including vacuum/anchor combination pad with wheels for mobility

\*vacuum pump not included

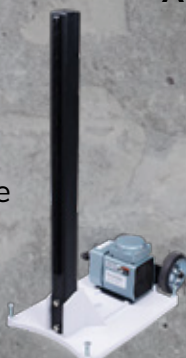

### ANGLED STAND

Gear type angle adjustable base of maximum of 120 degrees tilt







## SMD16

- Motor comes with slip clutch that can be easily adjusted from outside the motor and can be completed on the job site
- Max core bit length of 26" can be installed
- Feed handle can be placed on either right or left side of carriage for easy drilling close to walls and columns
- 4 adjustable leveling screws for drilling uneven surfaces
- Double insulated construction
- Swiveling water valve can be rotated full 360 degrees for added convenience
- Engineered for both vertical & horizontal drilling
- One-year limited warranty
- Automatic Feeding System available

## SPECIFICATIONS

Power	230V
Rated Current	15.8A
Max Output	2.4kw (3.2HP)
Max Bit Capacity	16" (with spacer)
Spindle Thread	1-1/4"-7
Column Thickness	2-5/16"
Stand Height	39-3/8"
Carriage Travel	24-3/8"
Anchor Base	7.5" x 10" (WxL)
Clutch Type	Slip
Speed	400/950 RPM (No Load)
Weight	63 lbs. (28.4 kg)



## SMD24

- Power requirement 3,630W
- Swiveling Water Supply Adapter: Water Supply Adapter can be positioned for necessary direction of water hose.
- Equipped with slipping clutch: Clutch torque can be easily adjusted at job site without disassembly of gear box.
- Circuit protector for over load protection
- One-touch handle: Spring-loaded self centering handle is easy to change left and right side on carriage without tool.
- One-year limited warranty
- Automatic Feeding System available

## SPECIFICATIONS

Power	230V, 15.8A drill motor
Max Bit Capacity	24"
Spindle Thread	1-1/4"-7
Column Thickness	2-5/16"
Stand Height	57"
Carriage Travel	23-5/16", Standard pole base 38", Swivel pole base
Anchor Base	7-7/8" x 12-1/2" (LxW)
Clutch Type	Slip
Speed	100/200 RPM
Weight	102 lbs. (46.3kg), Standard pole base 122 lbs. (55.3kg), Swivel pole base

### ADDITIONAL ACCESSORIES



#### SWIVEL STAND

Extra sub column attached, which can be rotated 360° for easier extraction of long cores

#### DUSTLESS CONNECTOR



Available for all sizes

**NEW**

#### AUTO FEED SYSTEM





## EIBENSTOCK DRE5 CORE DRILL

- Overload temperature control and GFCI over current cut-off with optical indicator
- Cut-off carbon brushes - protects the motor
- 3-speed oil bath gearbox - optimal lubrication
- Short compact design
- 100% Aluminum housing
- Integrated level bubble on motor and handle
- Side handle with connection for centering device or water collection
- Wet Use Only



Power	15AMP/110V
Load Speed	600 / 1,300 / 2,800 RPM
No-Load Speed	1,000 / 2,200 / 4,300 RPM
Spindle Connection	5/8"x11 UNC & 1 1/4"x7 UNC
Collar Diameter	60mm
Carrying Case	Included
Weight	16lbs

## EIBENSTOCK DRE4 CORE DRILL

- Wet drilling in reinforced concrete, natural stone, and asphalt
- Dry drilling in limestone, brick, block and other abrasive materials
- Ideal for plumbing, mechanical and electrical construction, as well as civil engineering and landscape construction
- Garden hose connector
- 3 speed 19.5 AMP hand-held core drill
- Wet or dry diamond core drill
- Water swivel and extraction port built into the spindle
- Easily switchable from hand-held to stand-mounted drilling
- Drill stand adjustable up to 45°
- Includes drill bit connections 5/8"-11 UNC and 1-1/4"-7 UNC



Power	19.5AMP/110V
Max Drilling Diameter	6"
Load Speed	
1. Gear 3 1/4" - 6 3/8"	0-510 RPM
2. Gear 1 3/4" - 3 1/4"	0-1150 RPM
3. Gear 1/2" - 1 3/4"	0-2500 RPM
Spindle Connection	5/8"x11 UNC & 1 1/4"x7 UNC
Collar Diameter	60mm
Carrying Case	Included
Weight	15lbs

## EIBENSTOCK DRE4-S CORE DRILL STAND

- Can be used with drill motors of various brands
- (Universal tool holder, Collar connection)
- Easy adjustment of drilling depth
- Easy to level
- Aluminum column provides high torsional strength
- Smooth running, hard-wearing, adjustable guides/bearings
- Change feed lever without any tool – easy selection of operating side
- Hole center indicator allows exact positioning
- Space-saving base
- Lightweight, robust drill stand
- Available vacuum pump (Model DRE4-V) to handle all types of applications (optional, sold separately)
- Stand adjustable up to 45° for angle drilling
- Includes mounting brackets and screws



Max Drilling Diameter	6"
Height	30"
Motor Mount	60mm
Drilling Angle	90-45 degrees
Weight (Stand Only)	21 lbs
Base Diameter (L x W)	15-1/2" x 9"
Anchor or Vacuum Base	Combination





# DUST EXTRACTORS



## DC3300

- To ensure a dust-free floor, the DC-3300 dust extractor is a powerful, highly efficient 2 stage vacuum system that collects all sizes of dust particles and prevents clogging by depositing large grit particles into the first canister and the small to medium grit particles in the main canister.

Width (small unit)	22"
Height (small unit)	39"
Width (large unit)	27"
Height (large unit)	49"
Weight (net)	182 lbs
Cubic Feet Per Minute (CFM)	330 CFM
Auto Pulse or Manual Shake	Manual
Power	110V/50Hz 220V (optional)
HEPA	Compatible



## DC350LM

- Introducing our most powerful single phase dust extractor. Three large, commercial-grade vacuum motors provide 330 CFM and 100" of water lift, which is plenty of power for small to mid-size floor grinders. The DC-350LM is equipped with a drop down dust collection system that has a separator built in to the bottom. The filters are HEPA. The DC-350LM is portable and easy to maneuver on job site floors. All steel construction with large wheels in back and small locking wheels in front. All accessories are included.

Width	26"
Height	66"
Weight (net)	152 lbs
Cubic Feet Per Minute (CFM)	330 CFM
Auto Pulse or Manual Shake	Manual
Power	110V/50Hz 220V (optional)
HEPA	Compatible



## DC150LM

- Portable and powerful single phase HEPA dust collector with two motors.
- Connect directly to equipment for dustless grinding and sanding.
- Provides fast recovery of bulk dry dust and debris found on construction abatement and restoration jobs.
- Complies with all OSHA in table 1 requirements.

Width	22"
Height	58"
Weight (net)	132 lbs
Cubic Feet Per Minute (CFM)	224 CFM
Auto Pulse or Manual Shake	Manual
Power	110V/50Hz 220V (optional)
HEPA	Compatible





# FS200-14K FLAT SAW

- Diamond Vantage® Walk Behind Saws are built from the ground up to provide years of reliable cutting. These saws will cut concrete and asphalt with little to no vibration because of their heavy-gauge steel frames, rugged shafts and bearing assemblies.
- Precision machined arbor shafts
- Multiple-belt power transfer system
- Superior rigidity for smooth, clean, straight cuts
- Heavy-Duty 7-gauge steel construction
- Large screw-type depth control locks for consistent cutting depth

Blade Capacity	14"
Weight	254lbs
Horse Power	14HP
Dimensions	49" x 27" x 40" (LxWxH)
Max Cut Depth	6- <sup>3</sup> / <sub>4</sub> "
Motor	Kohler





# FOLLOW US ON SOCIAL MEDIA

@DIAMONDVANTAGE



WATCH US ON  
**YOUTUBE**



FOLLOW US ON  
**INSTAGRAM**



JOIN OUR  
**LINKEDIN COMMUNITY**



CONNECT WITH US  
ON **FACEBOOK**



BROWSE OUR  
**WEBSITE**



**CHECK OUT WHAT WE'VE BEEN UP TO**



# TERMS & CONDITIONS

## TERMS & CONDITIONS

- 3%/15 days, Net 30 days
- Past due amounts are subject to one percent (1%) per month late charge, where permitted by law.

### Diamond Tool Warranty

- Laser Welded Blade/Bit Warranty: If the laser welded bond between the segment and the core or barrel fails within the first .050" of segment wear of the product\*, the blade or bit will be replaced free of charge.
  - Brazed Blade/Bit Warranty: If the brazed welded bond between the segment and the core or barrel fails within the first .050" of segment wear, the blade or bit will be repaired or replaced free of charge.
  - Continuous Rim Blade Warranty: If the bond between the diamond rim and core fails within the first .050" of segment wear of the blade, the blade will be replaced free of charge.
  - These warranties do not cover abuse to or misapplication of the blade or bit. Our obligation under this warranty is limited to replacement or repair at our Irvine, California facility.
- **Equipment Warranty: One Year Limited Warranty.**

Every Diamond Vantage® product sold is guaranteed to be free of defects in material and workmanship. Product warranty is limited to repair and replacement of any part, which under normal use is defective in material or workmanship. Warranties for machinery and equipment are provided by their respective manufacturers. Defective part(s) or product at issue should be returned to our address or to a place designated by us with transportation prepaid.

This warranty does not include cost to transport the product at issue. This warranty does NOT apply to any product that has been misused, neglected or involved in an accident. PLEASE NOTE ANY REPAIR, MODIFICATION OR ALTERATION OF A PRODUCT BY ANYONE OTHER THAN THE MANUFACTURER VOIDS ALL WARRANTIES DESCRIBED HEREIN. THIS WARRANTY COVERS ONLY THE PURCHASED PRODUCT.

**\*For diamond blades, the above Diamond Tool Warranty is only applicable to blades up to 14" in diameter. For all blades over 14", this warranty is only applicable during the first 50% of segment wear.**



## SALES POLICY

- Prices: Subject to change without notice. Prices in effect at time of shipment are applicable. All prices are in U.S. dollars. Prices quoted are without federal, state or local taxes of any type.
- Sales Tax: Sales tax will be charged where applicable unless a current tax exemption certificate is provided.

## FREIGHT POLICY

### Diamond Tools

- Orders over \$500.00 net are shipped ground FOB to ONE destination within the contiguous US. Customers to pay freight on all orders less than \$500.00.
- Customers who place one order to ship to multiple destinations, will be responsible for freight charges occurred for each additional destination that exceeds the maximum ONE destination that is included in the \$500.00 net pre paid free ground freight minimum.
- Requests for 3rd, 2nd, or next day shipments will be billed to the customer.
- Freight Charge: \$1500 prepaid to Alaska or Hawaii

### Equipment

- Equipment, parts, and accessories are shipped ground/truck with freight prepaid and added to the invoice.

## TRIAL POLICY

- Purchase orders are requested and full payment is expected on all trial blades. Trial blades will be invoiced on the basis of normal ordering, if the trial blades are successful payment in full is expected.
- Trial blades that are unsatisfactory will be issued full or partial credit depending on the usage. Customer and our Returns Department will jointly determine the efficiency of the trial performance.

## RETURNED GOODS POLICY

- All Returns are subject to a minimum 15% restocking fee.
- Discontinued items and items one (1) year or older from the original invoice date cannot be returned.
- The Customer Service Representative will issue a Return Goods Authorization (RGA) number for the return. Freight on returned merchandise must be paid by customer and merchandise must be in resalable condition.
- Customized and special order product cannot be returned.
- Only authorized shipments meeting the follow conditions will be accepted.
  1. RGA#
  2. Reasons for return
  3. Description of goods
  4. Copy of original invoices
- Special order items must be canceled within 30 days of ordering. Customer will be responsible for payment of special order after 30 days from order date.

This troubleshooting guide may help identify, diagnose, resolve and prevent diamond blade problems. The following are samples of some of the problems you may encounter in the field along with potential causes and prevention guides to help diagnose and prevent future problems.

**LOSS OF TENSION**

<b>CAUSE</b>	Blade core has been overheated.
<b>PREVENTION</b>	Provide proper amount of water to both sides of blade. Check to make sure water pump is producing sufficient water flow and that no blockages exist in the water lines.
<b>CAUSE</b>	Blade core has been overheated as a result of the blade spinning on arbor.
<b>PREVENTION</b>	Securely clamp the blade by tightening the flange nut and make certain that the drive pin is functioning on concrete saws.
<b>CAUSE</b>	Blade core has been overheated because of blade core rubbing side of material being cut.
<b>PREVENTION</b>	Properly align saw to permit straight cutting. Avoid twisting the blade in cut. Make certain that shaft RPM is correct, so that blade is operating at its tensioned speed, and consequently runs perfectly straight.
<b>CAUSE</b>	Unequal pressure at blade clamping collars.
<b>PREVENTION</b>	Blade clamping collars should be identical in diameter and the recommended size.

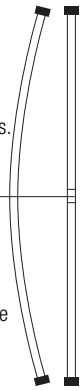

**DO NOT USE A BLADE THAT IS OUT OF TENSION!**

**BLADE WOBBLES**

<b>CAUSE</b>	Blade mounted on defective saw.
<b>PREVENTION</b>	Check for bad bearings, bent shaft, or worn mounting arbor. Also, check collars to make sure they are clean, flat, and of the manufacturer's recommended diameter.
<b>CAUSE</b>	Blade being run at improper operating speed.
<b>PREVENTION</b>	Make certain that blade shaft is turning at the recommended RPM to match the tensioned speed of the blade. Use a tachometer on concrete and stone saws to make certain blade shaft is turning and set at the proper speed.
<b>CAUSE</b>	Blade collar diameters are not identical. (Uneven pressure is created on the blade blank at the center.)
<b>PREVENTION</b>	Use proper size blade collars.
<b>CAUSE</b>	Blade bent as a result of dropping or twisting.

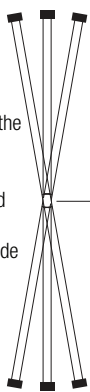

**DO NOT USE A BLADE THAT WOBBLES!**

**UNEVEN SEGMENT WEAR**



<b>CAUSE</b>	Insufficient water, generally on one side of the blade, which reduces side clearance.
<b>PREVENTION</b>	Flush water system. Make certain that water is being adequately and equally distributed to both sides of the blade.
<b>CAUSE</b>	Equipment defect, which causes the blade to wear out of round.
<b>PREVENTION</b>	Replace bad bearings, worn arbor shaft, or misaligned shaft on the concrete saw, and make certain the engine runs smoothly to prevent harmonic vibrations, which in turn causes the blade to pound on a regular cycle basis.
<b>CAUSE</b>	Saw head misaligned.
<b>PREVENTION</b>	Check saw head alignment for squareness, both vertically and horizontally.

**CRACKS IN STEEL CORE**

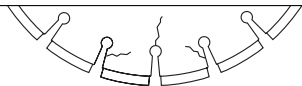

<b>CAUSE</b>	Blade flutters in cut as a result of loss of core tension.
<b>PREVENTION</b>	See "Loss of Tension" section.
<b>CAUSE</b>	Blade specification is too hard for material being cut.
<b>PREVENTION</b>	Use softer-bond blade to eliminate stresses which create cracks.

**DO NOT USE A BLADE WITH A CRACKED CORE!**

**UNDERCUTTING**

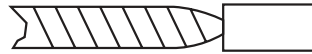

<b>CAUSE</b>	Abrading or wearing away of the steel center faster than the diamond segment. (Highly abrasive slurry is being generated during cutting.)
<b>PREVENTION</b>	Use as much water as possible to flush out slurry generated during cutting or use wear-retardant cores. <b>CAUTION:</b> Wear-retardant cores are not always the final answer to eliminating undercutting. Care must still be taken to provide sufficient water to the core area immediately adjacent to the segment. This is especially important when making deep cuts.

**DO NOT USE A BLADE IF IT IS UNDERCUT!**

**ARBOR HOLE OUT OF ROUND**

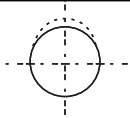

<b>CAUSE</b>	Blade collar is not properly tightened, permitting blade to either rotate or vibrate on shaft.
<b>PREVENTION</b>	Wrench-tighten arbor nut to make certain blade is adequately secured to prevent rotation on arbor shaft.
<b>CAUSE</b>	Worn or dirty blade collars, which do not allow proper blade clamping.
<b>PREVENTION</b>	Clean blade collars, make sure they are not worn, and tighten arbor nut properly.
<b>CAUSE</b>	Blade not properly mounted.
<b>PREVENTION</b>	Make certain blade is mounted on the proper diameter of the shaft before tightening arbor nut on concrete saw, and make certain that pin holes slide over arbor drive pin. Never depend on drive pin to actually drive the blade. A drive pin is simply a safety measure to prevent the blade from spinning on its mounting arbor, should the nut come loose.

**DO NOT USE A BLADE THAT IS OUT OF ROUND!**

## SEGMENT LOSS

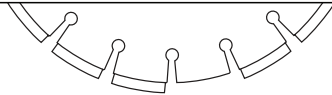

- CAUSE** The material was not held firmly, which caused the blade to twist or jam in the cut, causing segment loss.
- PREVENTION** Material must be held firmly.
- CAUSE** Overheating due to inadequate supply of water or complete loss of water. This is usually accompanied by discolorations which appear on the steel center in the area of the segment loss.
- PREVENTION** Provide adequate water flow to both sides of the blade, look for line blockages on concrete saw that could cause complete loss of water as a result from equipment running over water feed hoses.
- CAUSE** On the concrete saw the steel center worn thin as a result of undercutting by abrasive slurry generated during cutting. (Core wears to a knife edge, which weakens the weld/braze and causes segment loss).
- PREVENTION** Use sufficient water to flush slurry out of cut. If generated, slurry are highly abrasive and wear-retardant cores / undercut protection should be used.
- CAUSE** Defective blade collars which cause the blade to flutter in the cut or fail to adequately support the blade in perfect alignment.
- PREVENTION** Clean foreign material from blade collar surfaces, or replace collars under manufacturer's recommended diameter.
- CAUSE** Blade is too hard for material being cut causing excessive dullness and the segment separates due to impact or fatigue. (This can also be the cause of frictional heat, which can melt the brazing solder.)
- PREVENTION** Use proper blade specification for the material being cut.
- CAUSE** Blade is cutting out of round resulting in a pounding impact.
- PREVENTION** Replace worn bearings, re-align blade shaft, or replace worn blade-mounting arbor.
- CAUSE** Improper blade tension which produces high pressure on the segments and subsequent failure of the brazed joint (weld).
- PREVENTION** Make sure running speed of the equipment is specified when ordering blades. The spindle speed should be checked with a tachometer to ensure that each diameter blade is running at the manufacturer's recommended cutting speed and blade-tensioned speed.

**DO NOT USE A BLADE WITH A LOST SEGMENT!**

## SHORT LIFE



- CAUSE** Use of a soft-bonded blade for cutting abrasive material, or a cured concrete blade for cutting asphalt or green concrete. There are specific blades designed for each particular material to give the most economical cutting. Also avoid the use of general purpose specifications for cutting a single specific material. General purpose diamond blades are designed to cut a range of materials and, since it is unlikely the operator will be cutting proportionately the proper amount of both hard and soft materials at all times, this is not the economical method of cutting.
- PREVENTION** Use the proper blade specification, as recommended in this catalog.
- CAUSE** Inadequate water to the blade.
- PREVENTION** Make sure water hoses are clean and free from any blockages. Approximately two gallons of water per minute are required to properly cool a saw blade.
- CAUSE** Bad spindle bearings, worn mounting arbor, or misaligned shaft.
- PREVENTION** Replace defective parts.
- CAUSE** Loss of power, resulting from loose drive belts or improper voltage.
- PREVENTION** See instruction manual for proper belt tightening, replace worn belts, and make sure proper line voltage is being supplied to the motor.

## CRACKS IN SEGMENT

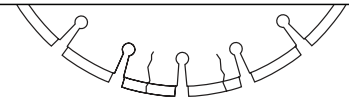

- CAUSE** Blade is too hard for material being cut.
- PREVENTION** Use blade with softer bond.

**DO NOT USE A BLADE WITH A CRACKED SEGMENT!**

## BLADE WILL NOT CUT



- CAUSE** Blade bond is too hard for material being cut. (Improper blade specification.)
- PREVENTION** Consult blade recommendation chart or manufacturer for the proper blade specification for the material being cut.
- CAUSE** Blade has become dull, probably as a result of being used on too hard a material.
- PREVENTION** Dress or sharpen with soft concrete block, piece of sandstone, or in asphalt to expose diamonds. If continual dressing is required, this would indicate that the blade specification is too hard for the material being cut.
- CAUSE** Failure to initially break in new blade on specific material being cut.
- PREVENTION** Allow blade to sharpen itself on the material to be cut when first placing it on the saw. This is the proper way to break in a blade.
- CAUSE** Insufficient power to permit blade to cut properly.
- PREVENTION** Tighten belts in accordance with machine maintenance instruction. Use correct voltage at motor and use adequate horsepower for cutting application.







Date \_\_\_\_\_

Customer \_\_\_\_\_

Company and/or REP \_\_\_\_\_

## PRODUCT TEST REPORT

### PRODUCT DETAIL

Product code (or sales order #) \_\_\_\_\_

Diameter \_\_\_\_\_

Segment Spec \_\_\_\_\_

**TEST PLACE** Area \_\_\_\_\_

Highway  Road  Building  Etc \_\_\_\_\_

### MATERIAL CUTTING

#### Types of Material

Cured Concrete  Reinforced Concrete  Green Concrete  Abrasive Concrete  Asphalt

Overlay  Etc \_\_\_\_\_

#### Types of Aggregate

Flint  River Gravel  Hard Granite (Quartz)  Natural Stone  Limestone  Asphalt

#### Hardness of Concrete or Agregate

Hard  Medium  Soft  Etc \_\_\_\_\_

Reinforcement Diameter of rebar \_\_\_\_\_

**Layers of Reinforcement:**  1-layer  2-layers  3-layers  Etc \_\_\_\_\_

### MACHINE

Power of Machine (Model, HP) \_\_\_\_\_

Diesel  Gasoline  Electric  High Frequency Electric  Hydraulic  Etc \_\_\_\_\_

#### Types of Machine

Walk Behind  Wall Saw  Core Drill  Handheld  Etc \_\_\_\_\_

### TEST CONDITION & RESULT

Machine RPM \_\_\_\_\_

Cutting Depth \_\_\_\_\_

Cutting Speed \_\_\_\_\_

Life (Liner ft) \_\_\_\_\_

Comments \_\_\_\_\_

\_\_\_\_\_

\_\_\_\_\_

\_\_\_\_\_







# MANUFACTURING IN THE USA

Diamond Vantage® excels in the industry by maintaining full control over the manufacturing process of our comprehensive range of construction diamond tooling products. By overseeing production from start to finish, we ensure superior quality, precision, and consistency in every blade and tool we produce.

Our commitment to manufacturing some of our blades in the USA further enhances our ability to uphold stringent quality standards and respond swiftly to market needs. This localized production not only supports local economies but also allows us to innovate more effectively and tailor our products to meet specific customer requirements.

Diamond Vantage's dedication to in-house manufacturing positions us at the forefront of the industry, delivering reliable, innovative, high-performance diamond tools trusted by all professionals.



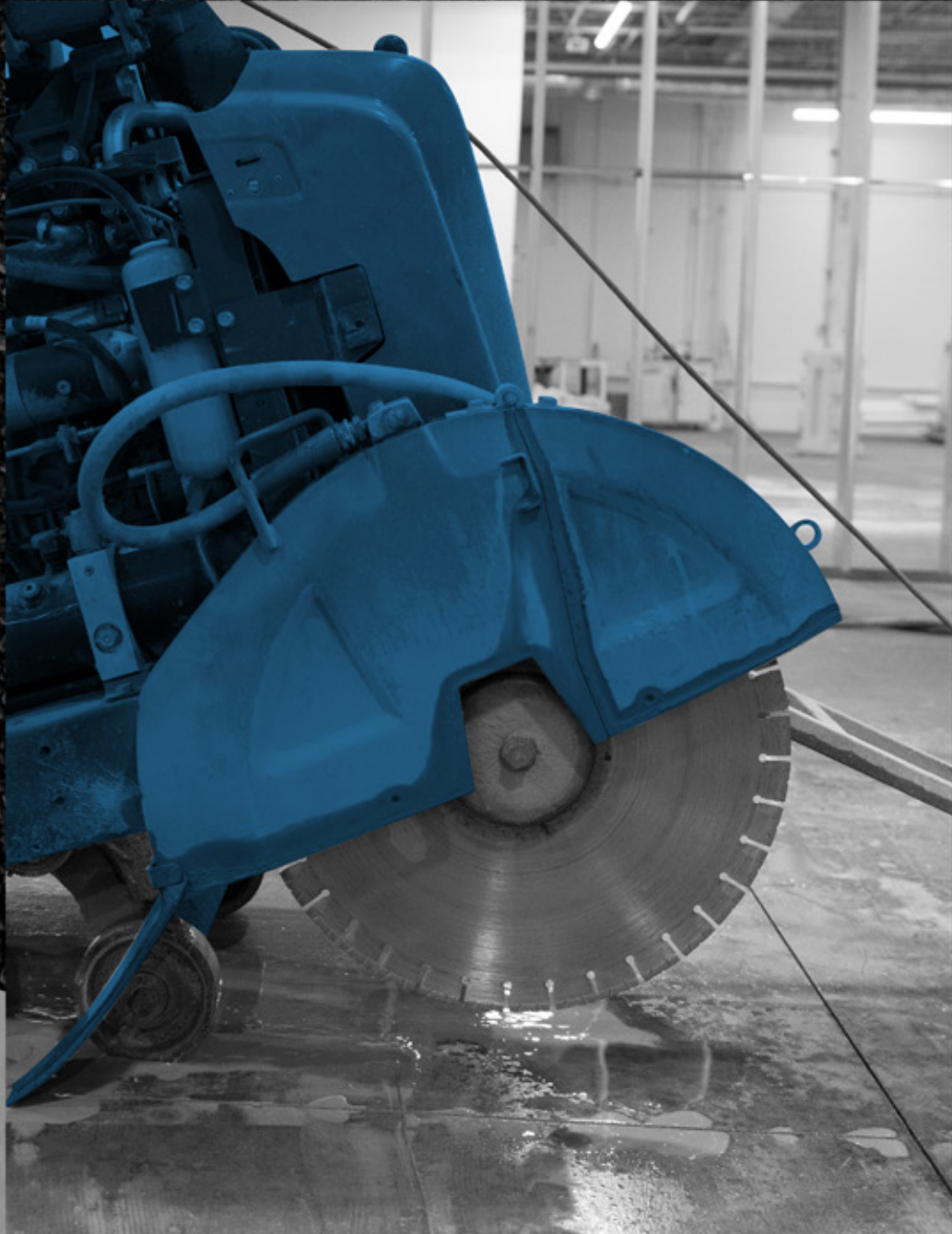

DIAMONDVANTAGE.COM



866-322-4078